



EQUILIBRATRICE
WHEEL BALANCER
ÉQUILIBREUSE
AUSWUCHTMASCHINE
EQUILIBRADORA

B 215 Evo
B 225 Evo

Cod. 4-119451B del 03/2018

Italiano
English
Français
Deutsch
Español

Manuale d'uso
Operator's manual
Utilisation et entretien
Betriebs und Wartungsanleitung
Uso y mantenimiento

TRANSLATION FROM ORIGINAL INSTRUCTIONS (ITALIAN) CONTENTS

INTRODUCTION	69
TRANSPORT, STORAGE AND HANDLING	70
INSTALLATION	71
ELECTRICAL HOOK-UP.....	74
COMPRESSED AIR HOOK-UP	75
SAFETY REGULATIONS.....	75
MAIN FEATURES	77
TECHNICAL DATA.....	78
STANDARD EQUIPMENT	79
GENERAL CONDITIONS OF USE.....	80
DISPLAY PANEL	81
DISPLAY PANEL - STATUS ICON	81
DISPLAY PANEL - CONTROL KEYPAD	82
1. SWITCHING ON THE MACHINE.....	83
2. BALANCING PROGRAMME SELECTION	84
3. ENTERING WHEEL DIMENSIONS (ALU1P AND ALU2P PROGRAMMES EXCLUDED)	85
4. ENTERING WHEEL DIMENSIONS IN BALANCING PROGRAMMES ALU1P OR ALU2P.....	90
5. ENTERING DIMENSIONS IN THE MOTORCYCLE PROGRAMMES.....	93
6. WHEEL SPIN	93
7. UNBALANCE DISPLAY WITHOUT ROUNDING-OFF	94
8. APPLYING BALANCING WEIGHTS	94
9. APPLYING BALANCING WEIGHTS IN THE ALU1P OR ALU2P PROGRAMMES	96
10. PROGRAM FOR POSITIONING THE WEIGHTS BEHIND THE SPOKES "HIDDEN WEIGHT" (ONLY WITH ALU 1P AND ALU 2P PROGRAMMES)	98
11. PROGRAM FOR DIVIDING THE WEIGHT ON EITHER SIDE OF THE SPOKE "SPLIT WEIGHT" (ONLY WITH MOTORCYCLE PROGRAMMES)	100
12. UNBALANCE OPTIMISATION PROGRAMME "OPT"	101
13. ENABLING THE OTHER OPERATOR	103
14. SPIN COUNTER.....	103
15. GENERAL CONFIGURATIONS - SET UP	104
15.1. SET UP - SELECTING VEHICLE TYPE (CAR-MOTORCYCLE).....	105



15.2. SET UP – SELECTING THE MODE FOR ACQUIRING WHEEL DIMENSIONS IN BALANCING PROGRAMMES ALU1 AND ALU2....	106
15.3. SET UP - UNBALANCE UNIT OF MEASURE.....	107
15.4. SET UP - UNBALANCE ROUNDING-OFF	108
15.5. AUTOMATIC POSITION SEARCH.....	109
15.6. SET UP - WARNING OPT	109
15.7. SET UP - RIM DIAMETER DISPLAY UNIT OF MEASUREMENT	110
15.8. SET UP - RIM WIDTH DISPLAY UNIT OF MEASUREMENT	111
15.9. SET UP – ACOUSTIC SIGNAL.....	111
15.10. SET UP - ADHESIVE WEIGHT APPLICATION POSITION (H3-H6-H12)	112
15.11. SET UP - BRIGHTNESS DISPLAY SETTING.....	114
15.12. SET UP - LED LIGHT (IF PROVIDED)	115
15.13. SET UP - LASER INDICATOR (IF PROVIDED)	115
16. UNBALANCE CALIBRATION WITH CALIBRATION WEIGHT	116
17. EXTERNAL MECHANICAL SENSOR CALIBRATION (IF INSTALLED).	117
18. DISPLAY MESSAGES.....	118
19. OTHER MESSAGES.....	120
CORRECT FUNCTION OF BALANCING ACCESSORIES.....	121
TROUBLESHOOTING	122
MAINTENANCE.....	124
SCRAPPING.....	124
ENVIRONMENTAL INFORMATION.....	124
RECOMMENDED FIRE EXTINGUISHING DEVICES	125
GLOSSARY	126
GENERAL ELECTRICAL INSTALLATION DIAGRAM	127

INTRODUCTION

The purpose of this manual is to provide the owner and operator with effective and safe instructions for the use and maintenance of the wheel balancer.

Follow all of the instructions carefully and your machine will assist you in your work and give long-lasting and efficient service, in keeping with manufacturer traditions.

The following paragraphs define the levels of danger regarding the machine, associated with the warning captions found in this manual.

DANGER

Refers to immediate danger with the risk of serious injury or death.

CAUTION

Dangers or unsafe procedures that can cause serious injury or death.

WARNING

Dangers or unsafe procedures that can cause minor injuries or damage to property.

Read these instructions carefully before starting the machine. Keep this manual and all illustrative material supplied with the machine in a folder near it where it is readily accessible for consultation by the operators.

The technical documentation supplied is considered an integral part of the machine; in the event of sale all relative documentation must remain with the machine.

The manual is only to be considered valid for the machine model and serial number indicated on the data plate.



CAUTION

Adhere to the contents of this manual: The producer declines all liability in the case of actions not specifically described and authorised in this manual.

NOTE

Some of the illustrations contained in this manual were derived from photos of prototypes: the standard production machines may differ in some details.

These instructions are for the attention of personnel with basic mechanical skills. We have therefore condensed the descriptions of each operation by omitting detailed instructions regarding, for example, how to loosen or tighten the fixing devices on the machine. Do not attempt to perform operations unless properly qualified and with suitable experience. If in need of assistance, call an authorised assistance centre.

UK

TRANSPORT, STORAGE AND HANDLING

Handling and manoeuvring before installation

The basic wheel balancer packaging consists of 1 wooden crate containing:

- the wheel balancer
- equipment;

Before installation, the wheel balancer must be shipped in its original packaging, making sure that the machine is maintained in the position indicated on the outer packaging. The machine can be moved by placing the packaging on a wheeled trolley or inserting the forks of a fork lift truck in the relative slots in the pallet (Fig. 1).

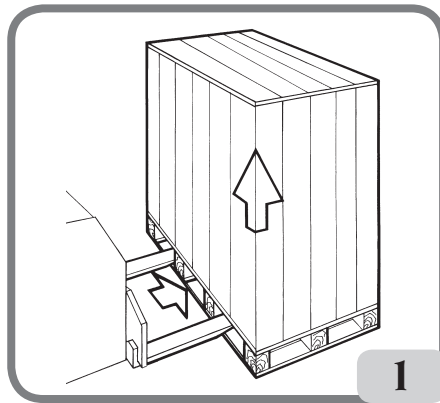

- Packaging dimensions:

Length	Depth	Height	Weight	Packaging weight
(mm)	(mm)	(mm)	(kg)	(kg)
1150	990	1175	110	30

- The machine must be stored in an environment meeting the following requirements:
 - relative humidity ranging from 20% to 95%;
 - temperature ranging from -10° to +60°C.



WARNING

Do not stack more than two packs to avoid damaging them.

After installation, the machine can be moved using the following methods:

- with a crane, using special equipment that holds the machine at the designated lifting points (Fig. 2);
- by inserting the forks of a lift truck under the machine so that the centre of the forks correspond approximately to the centre line of the body (Fig. 3).

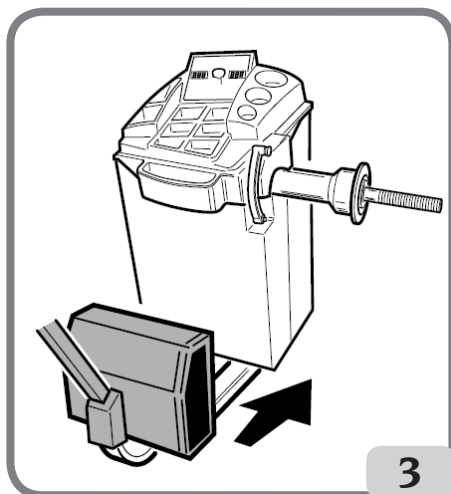
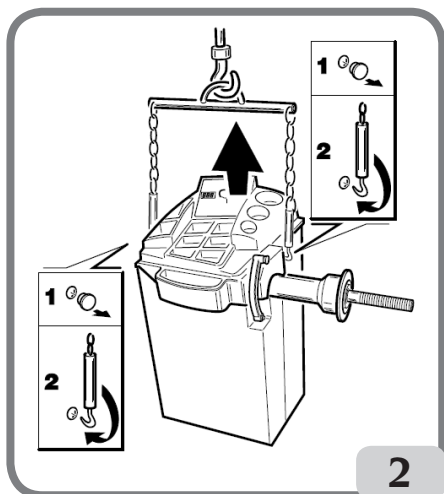

CAUTION

Always unplug the power supply cable from the socket before moving the machine.



CAUTION

Never apply force to the wheel spin shaft when moving the machine.

INSTALLATION



CAUTION

Take the utmost care when unpacking, assembling, lifting and setting up the machine as indicated below.

Failure to observe these instructions can damage the machine and compromise the operator's safety.

Remove the original packaging materials after positioning them as indicated on the packaging and **keep them intact so the machine can be safely shipped at a later date if necessary.**



CAUTION

Choose the place of installation in compliance with local regulations on occupational safety.

In particular, the machine must only be installed and used in protected environments where there is no risk of anything dripping onto it.

IMPORTANT: for the correct and safe operation of the machine, the lighting level in the place of use should be at least 300 lux.

The floor must be strong enough to support a load equal to the weight of the equipment

plus the maximum load allowed. The support base on the floor and the envisaged fixing means must also be taken into account.

Environmental operating conditions must comply with the following requirements:

- relative humidity ranging from 30% to 80% (without condensation);
- temperature ranging from 0° to +50°C.



WARNING

For information concerning the technical features, warnings and maintenance instructions consult the related operator manuals provided with the documentation of the machine.



CAUTION

The machine must not be operated in potentially explosive atmospheres.

The machine is supplied partially disassembled and is to be assembled according to the procedures described below.

Fixing the machine to the ground (Fig. 5)

The machine is to be fixed to the ground if:

- It does not have the accessory triangular foot.
- If it does have the accessory triangular foot but is going to be used with wheels heavier than 50Kg. In such a case the triangular foot will have to be removed in order to fix the front bracket.
- Undo the three M8x60 hex head screws fastening the machine to the pallet.
- Remove the plastic washers between the casing and the three L brackets: these brackets will be used to fasten the machine to the floor.
- Refit the brackets on the machine in the original positions, without tightening the screws.
- Position the machine on the ground in the selected position and make sure that the surrounding spaces correspond to the minimum values indicated in Fig. 4.
- Trace the position for drilling on the floor.
- Drill in the traced position and then take the included Fischer M8 and insert them into the holes that were made.
- Secure the machine to the floor by fastening the L brackets to the Fischer anchor bolts using the relative screws and washers (fig.5).
- Tighten the three fastener screws to the casing.

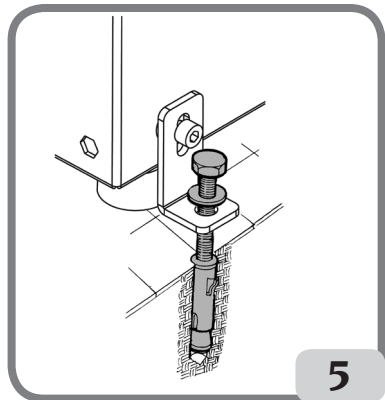
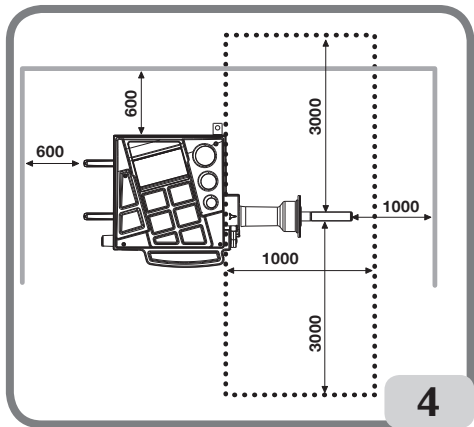

Fitting the external mechanical sensor and relative support (if available)

- Fasten the external sensor support to the wheel balancer body using the three screws supplied with the machine (A, fig.5b);
- Insert the external sensor pin (B, fig.5b) in the sensor support bush (C, fig.5b);
- Screw the screw (D, fig.5b) bringing it closer to the sensor pin without touching it;
- Make sure that the external sensor rotates freely;
- Connect one of the sensor's cable connectors to the socket located on the sensor body (H, fig. 5a);
- Tape the cable to the sensor support (F, fig. 5b) so that it is never tensioned;
- Connect the sensor cable connector to the machine's rear panel (G, fig.5b).

IMPORTANT: after installing the external sensor, calibrate the sensor as described in the paragraph "Width sensor calibration".

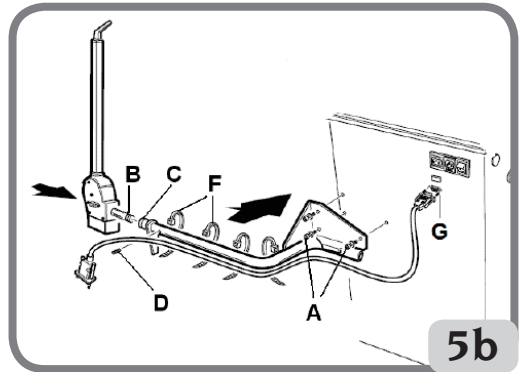
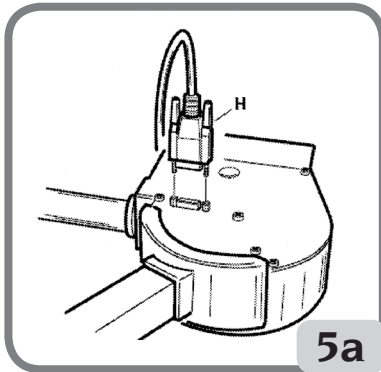

After installing the machine, move into the selected location, ensuring that the spaces surrounding the machine comply with the minimum dimensions indicated in Fig. 5a.

Main working parts (Fig. 8)

- (A) automatic diameter and distance measuring arm
- (B) automatic width measuring arm (if present)
- (D) display panel
- (E) flange holder
- (F) weight tray
- (G) wheel support shaft
- (H) cone holder
- (I) handling holes
- (L) wheel-holder shaft locking brake (on request)

UK

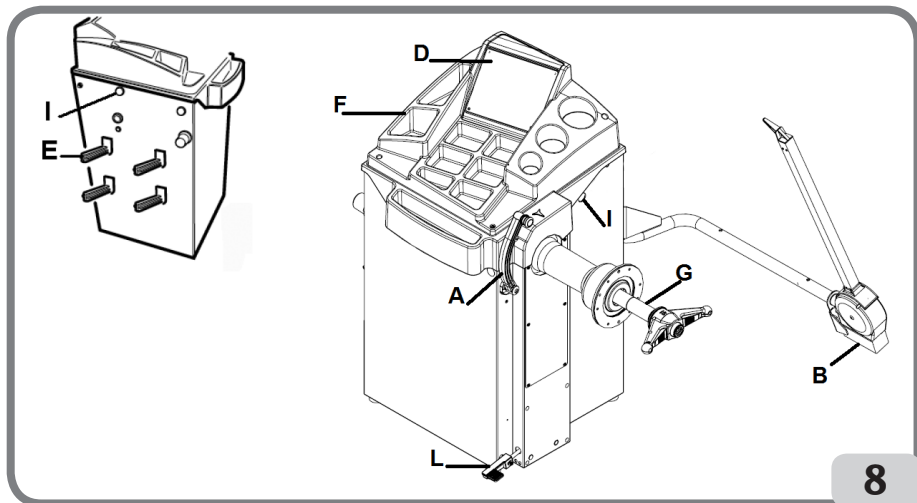

ELECTRICAL HOOK-UP

On request, the wheel balancer can be set up by the manufacturer to operate with the power supply available in the place of installation. The set-up data for each machine are given on the machine data plate and on a special label attached to the power supply connection cable.



CAUTION

Any operations for hooking up to the workshop electrical board must be carried out only by qualified technicians in compliance with the regulations in force, under the responsibility and at the charge of the customer.

- The electric hook-up must be performed according to:
 - absorbed power specifications indicated on the machine dataplate;
 - the distance between the machine and the electric hook-up point, so that voltage drops under full load do not exceed 4% (10% when starting up) of the rated voltage specified on the data plate.
- The user must:
 - fit a plug that respects the current regulations onto the power supply cable;
 - connect the machine to its own electrical connection fitted with a suitable 30-mA current sensitive circuit breaker;
 - fit power supply protection fuses sized in compliance with specifications in the main wiring diagram of this manual;
 - provide the workshop electric installation with an efficient grounding circuit.
- Prevent unauthorised use of the machine, always disconnect the power supply plug when the machine is not used (switched off) for extended periods of time.
- If the machine is connected directly to the power supply by means of the main electrical board and without the use of a plug, install a key-operated switch or suitable lock-out device to restrict machine use exclusively to qualified personnel.



CAUTION

For the machine correct functioning it is vital to have a good ground connection. NEVER connect the machine ground wire to a gas pipe, water pipe, telephone cable or any other unsuitable object.

COMPRESSED AIR HOOK-UP



WARNING

The compressed air hook-up may only be performed if the pneumatic ring nut is supplied (optional accessory supplied on request).



CAUTION

All compressed air hook-ups must be carried out by qualified personnel only.

- The hook-up to the workshop compressed air system must ensure a minimum pressure of 8 bar.
- A universal union is used for connection to the compressed air system. No special or additional adaptor is needed for connection. A pressure-resistant hose with 6mm inner diameter and 14mm outer diameter must be fastened to the notched union using the clamp provided with the machine.

SAFETY REGULATIONS



CAUTION

Non-compliance with the instructions and danger warnings can cause serious injuries to the operator or other persons.

Do not operate the machine until you have read and understood all the danger/warning notices in this manual.

In order to operate the machine correctly, it is necessary to be a qualified and authorised operator, able to be trained and to know the safety regulations. Operators are expressly forbidden from using the machine under the influence of alcohol or drugs capable of affecting physical and mental capacity.

The following conditions are essential:

- the operator must be able to read and understand the contents of this manual;
- have a thorough knowledge of the features and characteristics of the machine;
- keep unauthorised persons well clear of the working area;
- make sure that the machine has been installed in compliance with all relevant standards and regulations in force;
- make sure that all machine operators are suitably trained, that they are capable of using the machine correctly and safely and that they are adequately supervised during work;
- do not touch power lines or the inside of electric motors or any other electrical equipment before making sure that they have been powered off;

UK

- read this booklet carefully and learn how to use the machine correctly and safely;
- always keep this user manual in a place where it can be readily consulted and do not fail to refer to it.



CAUTION

Do not remove or deface the DANGER, WARNING, CAUTION or INSTRUCTION decals. Replace any missing or illegible decals. If one or more decals have been detached or damaged, they can be replaced by your nearest manufacturer dealer.

- When using and carrying out maintenance on the machine, observe the unified industrial accident prevention regulations for high voltage industrial equipment and rotating machinery.
- Any unauthorised modification to the machine releases the manufacturer of all liability in the event of damage or personal injury resulting from said modification. Specifically, tampering with or removal of the machine safety devices is a breach of the regulations relating to Safety at Work.



CAUTION

During work and maintenance operations, always tie back long hair and do not wear loose clothing, ties, necklaces, wristwatches or any other items that may get caught up in the moving parts.

Key to caution and instruction labels



Never use the wheel spin shaft as a lifting point for the machine.



Unplug the power supply plug before performing any maintenance/repair operations on the machine.

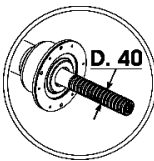

Please use centring accessories with hole diameter 40 mm.

MAIN FEATURES

- Low balancing speed:
 - minimises wheel spin times;
 - reduces risk due to rotating parts;
 - saves energy.
- Automatic sensor for distance and diameter measurement.
- Automatic mechanical sensor for width measurement (if present).
- LaserRay pointer system, ie laser line within the automatic detection arm to indicate balancing plane acquisition position (available on request).
- AWC" (Auto Width Calculation) programme for enabling the manual insertion of the width (if present).
- Automatic brake for stopping the wheel at the end of the spin.
- Wheel-holder shaft locking brake.
- STOP button to stop the machine immediately.
- Side flange holders.
- Top tray to take weights of all types.
- Luminous digital display unit double display and 3D graphics.
- Microprocessor processing unit (16 bit).
- Resolution: 1g (1/10oz).
- Wide selection of programmes making the machine easy to use.
- Unbalance value display in grams or ounces.
- Unbalance display rounding-off setting.
- Balancing modes available:
 - *Standard* dynamic on both rim sides
 - *Alu / Alu P* seven different routines for alloy rims
 - *Motorcycle Motorcycle* dynamic on both sides for motorcycle rims
 - *Motorcycle ALU* dynamic on both sides of alloy motorcycle rims
 - *Static* on a single side.
- **"Shift planes"** programme (in Alu P) for using multiple five gram weights, i.e.: available without the need for partial cuts.
- **"Hidden Weight"** programme (in Alu P) in order to divide the outer side balancing adhesive weights into two equal weights positioned behind the spokes of the rim.
- **"Split Weight"** programme (motorcycle programmes) to divide the weight into two equivalent values to be placed on either side of the spoke.
- **"OPT flash"** programme for rapid optimisation of operating noise reduction.
- **"FSP"** (Fast Selection Program) programme for the automatic selection of the balancing programme.
- General utility programmes:
 - calibration
 - service
 - diagnostics.
- Independent working environments that allow a maximum of two operators to work in parallel with no need to reset any data.
- RPA: automatic wheel positioning in the position where the balancing weight has to be applied (if present).
- Possibility to select the position for applying the adhesive weight:
 - Vertical plane in the lower part of the wheel (H6) using the LASER line
 - Vertical plane in the upper part of the wheel (H12)



- CLIP: using the weight-holder terminal in the ALUP balancing programmes (in all the other H12 balancing programmes)
- LED light (if present).
- LASER indicator (if present).

TECHNICAL DATA

- Single-phase power supply voltage 100/115 \pm 10%, 200/230 V \pm 10%, 50/60 Hz
- Rated power..... 100 W
- Rated current 1 A at 100-115V, 0.5A at 200-230V
- Balancing speed90/130 rpm
- Maximum unbalance value calculated 999 grams
- Average spin time (with 5"x14" wheel) 7 sec
- Shaft diameter 40 mm
- Ambient work temperature.....5° to 40°C
- Electrical / electronic components weight 4 kg

Machine dimensions (Fig. 9-9a)

- depth without the automatic sensor for measuring width 583 mm
- depth with the automatic sensor for measuring width 861 mm
- width without automatic width measurement sensor 1195 mm
- width with automatic width measurement sensor 1389 mm
- height 1022 mm

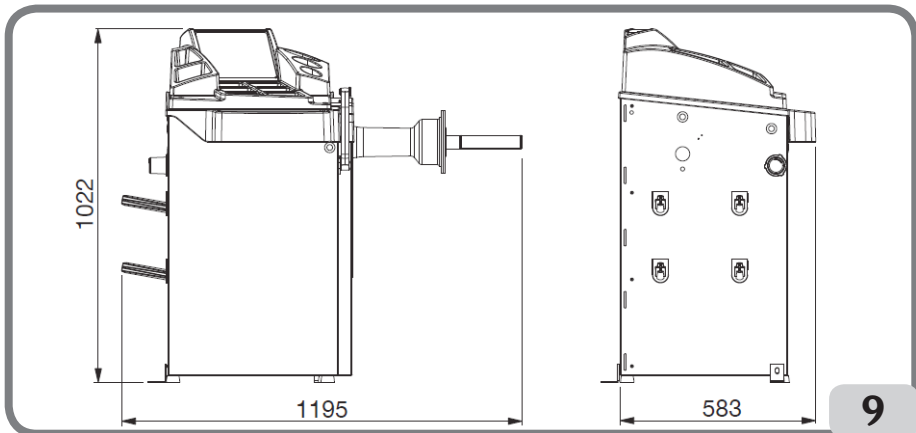

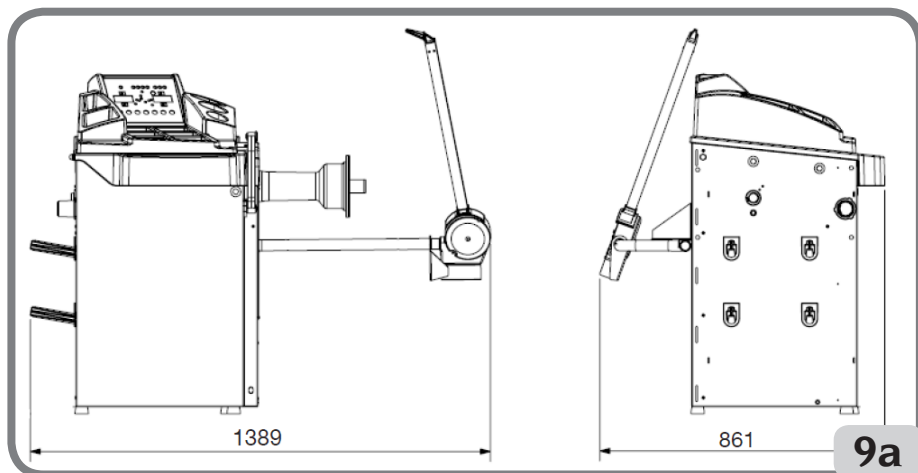

Working range

- settable rim width from 1.5" to 25"
- rim diameter measurable with the sensor (version with automatic sensor) .from 11" to 28"
- settable rim diameter from 1" to 35"
- max. wheel/machine distance 360 mm
- max. wheel width 600 mm
- Max. wheel diameter 1117 mm
- Max. wheel weight 75 kg
- Machine weight (without accessories) and without the external measuring sensor 70 kg
- Machine weight (without accessories) and with the external measuring sensor 78 kg
- Noise level in operation < 70 dB(A)

UK

STANDARD ACCESSORIES

The following parts are supplied together with the machine.

- Weight pliers
- Threaded hub
- Calliper for wheel width measurement
- Hexagon wrench, size 10
- Calibration weight
- Power cable
- Small cone
- Medium cone
- Large cone
- Small wheel fixing cap protection
- Spacer cap
- Small wheel fixing cap
- Quick fastener ring for locking wheel

GENERAL CONDITIONS OF USE

The equipment is intended for professional use only.



CAUTION

Only one operator at a time can work with the machine.

The wheel balancers described in this manual must be used **exclusively** to measure the extent and position of car wheel unbalances, within the limits specified in the Technical specification section.



CAUTION

Any use of the machine other than the described use is to be considered as improper and unreasonable.



WARNING

Do not start the machine without the wheel locking equipment.



WARNING

Do not clean or wash the wheels mounted on the machine with compressed air or jets of water.



CAUTION

When working, never use equipment not manufactured by the manufacturer.



CAUTION

Get to know your machine: The best way to prevent accidents and obtain top performance from the machine is to ensure that all operators know how the machine works. Learn the function and location of all the controls.

Carefully check that all controls on the machine are working properly.

To prevent accidents and personal injury, all the equipment must be correctly installed, correctly operated and correctly serviced.

POSITION OF THE OPERATOR

In fig. 9b are the positions occupied by the operator during the various work phases:

A Mounting / disassembling operations, launch, dimension detection (where provided) and wheel balancing

B Machine programs selection

In this way, the operator is able to perform, monitor and verify the outcome of each wheel balancing and intervene in case of unforeseen events.

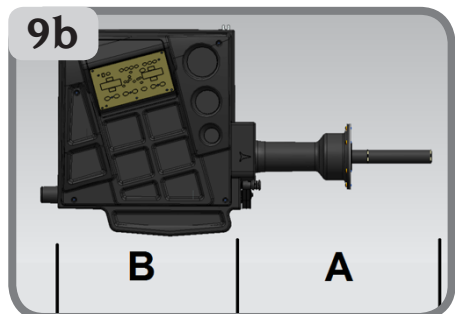



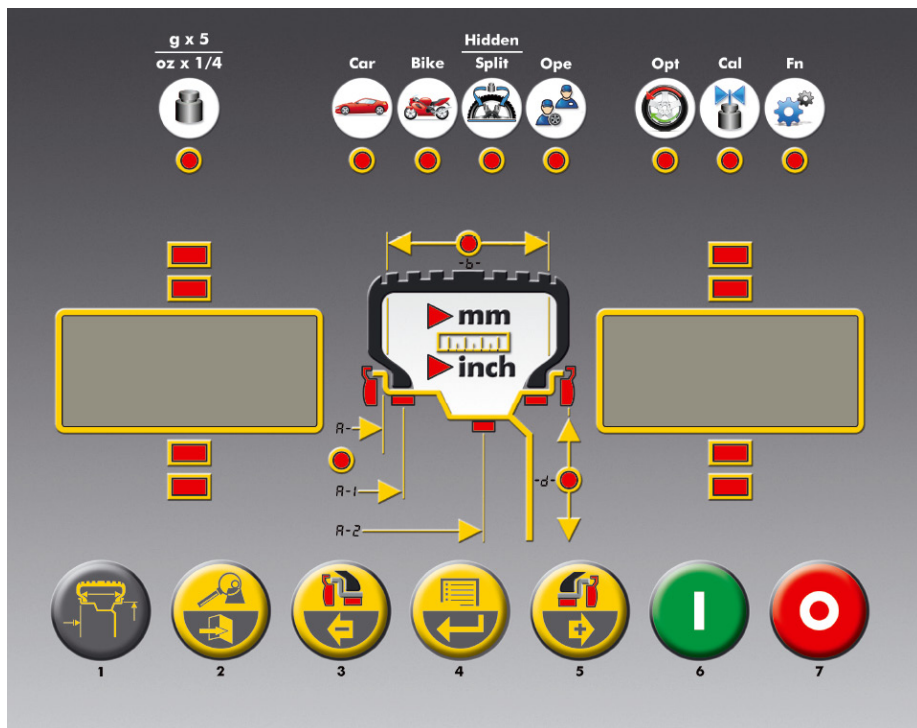



DISPLAY PANEL

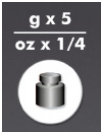
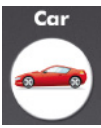

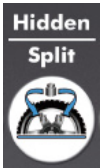

DISPLAY PANEL - STATUS ICON



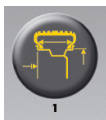

UK

STATUS ICON		DESCRIPTION
	Unbalance rounding-off	Unbalance rounding-off to 5 grams or 0.25 ounces. If off, the rounding-off is to 1 gram or 0.10 ounce.
	Car environment	Car environment active, the balancing programmes are dedicated to wheels for cars and lightweight transport vehicles.
	Motorcycle environment	Motorcycle environment active, the balancing programmes are dedicated to motorcycle wheels.

STATUS ICON		DESCRIPTION
	Hidden weight:	Hidden Weight function active (with car mode active) or Split Weight function (with motorcycle mode active).
	Operator 2	Operator 2 active. If off, the active operator is 1.
	Optimisation	Unbalance optimisation function active (OPT).
	Unbalance calibration	Unbalance calibration function active.
	Not available	Not available.

DISPLAY PANEL - CONTROL KEYPAD

KEY		DESCRIPTION
1		<p>Wheel dimensions</p> <p>- Press this key to manually enter the wheel dimensions in the case of an automatic measurement system malfunction or for versions with a manual internal sensor.</p>
2		<p>Multifunction key</p> <p>1. In balancing mode, press this key to temporarily display the value rounded to the gram or 1/10 of ounce.</p> <p>Note: for ALU1P and ALU2P balancing programs with shift plane, this key is not enabled.</p> <p>2. In a menu or in a program, press this key to exit.</p>

3		Internal weight selection/Decrease	<p>Multifunction key</p> <ol style="list-style-type: none"> 1. In balancing mode, press this key to select the type of weight to use on the inner side of the wheel. 2. In the menu press this key to navigate. 3. When entering dimensions manually, press this key to decrease the displayed value.
4		Menu / Enter	<p>Multifunction key</p> <ol style="list-style-type: none"> 1. In balancing mode, press this key to access the wheel balancer menu. 2. In a menu or in a program, press this key to change the viewed option.
5		Outer weight selection/Increase	<p>Multifunction key</p> <ol style="list-style-type: none"> 1. In balancing mode, press this key to select the type of weight to use on the outer side of the wheel. 2. In the menu press this key to navigate. 3. When entering dimensions manually, press this key to increase the displayed value.
6		Start	- Press this key to perform a spin.
7		Stop	- Press this key to stop the spin.

1. SWITCHING ON THE MACHINE

UK

Connect the power supply cable (A, Fig.10) supplied with the machine from the external electrical panel located on the rear side of the wheel balancer body to the mains.

Switch on the machine using the switch on the rear side of the body (B, Fig.10).

The wheel balancer performs a checking test (all the LEDs illuminate), and if no faults are detected, a beeper sounds and the cycle status initially active is displayed, as follows:

- active balancing mode: dynamic (dyn);
- values displayed: 000 000;
- grams displayed in units of 5 (or 1/4 of an ounce);

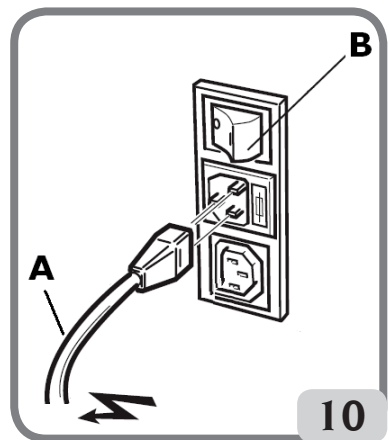

- active sensor rounding-off (version with digital sensor);
 - default geometric values: width = 5.5", diameter = 14", distance = 150 mm.
- Now the operator can set the data of the wheel to be balanced or select one of the programmes available.

2. BALANCING PROGRAMME SELECTION

Before starting a balancing operation, the following steps must be followed:

- fit the wheel on the hub using the most suitable flange;
- lock the wheel so that no movement is possible during the wheel spin and braking phases;
- remove any counterweight, pebble, dirt or other foreign body;
- set the wheel's geometric data correctly.

At start-up, by default, the wheel balancer executes the dynamic programme (dyn) which uses clip weights on both sides.



The various balancing programmes can be recalled by simply selecting the keys



that represent the type of weight according to the rim and professional experience, both for the inner side as well as for the outer side.

The following balancing programmes are available:

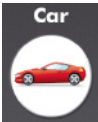
Vehicle type	Balancing programme	Inner weight application type and mode	External weight application type and mode
	dyn	$\frac{g \times 5}{oz \times 1/4}$ clip weight to apply manually at the 12 o'clock position	clip weight to apply manually at the 12 o'clock position
	ALU 1P	$\frac{g \times 5}{oz \times 1/4}$ Adhesive weight to apply manually at the 12* o'clock position or using weight holder if present	adhesive weight to apply manually at the 12* o'clock position or using weight holder if present
	ALU 2P	$\frac{g \times 5}{oz \times 1/4}$ clip weight to apply manually at the 12 o'clock position.	adhesive weight to apply manually at the 12* o'clock position or using weight holder if present.
	ALU 3	$\frac{g \times 5}{oz \times 1/4}$ adhesive weight to apply manually at the 12* o'clock position.	adhesive weight to apply manually at the 12* o'clock position
	ALU 4	$\frac{g \times 5}{oz \times 1/4}$ clip weight to apply manually at the 12 o'clock position	adhesive weight to apply manually at the 12* o'clock position.

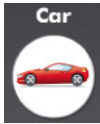
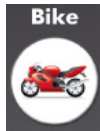
	ALU 5	$\frac{g \times 5}{oz \times 1/4}$	adhesive weight to apply manually at the 12* o'clock position.	clip weight to apply manually at the 12 o'clock position
	STA	$\frac{g \times 5}{oz \times 1/4}$	clip or adhesive weight to apply manually at the 12 o'clock position either on the outer or inner side or at the centre of the rim well clip weight to be applied manually at the 12 o'clock position	
	ALU 1	$\frac{g \times 5}{oz \times 1/4}$	Adhesive weight to apply manually at the 12* o'clock position	Adhesive weight to apply manually at the 12* o'clock position
	ALU 2	$\frac{g \times 5}{oz \times 1/4}$	clip weight to apply manually at the 12 o'clock position	Adhesive weight to apply manually at the 12* o'clock position.
	dyn BIKE	$\frac{g \times 5}{oz \times 1/4}$	clip weight to apply manually at the 12 o'clock position	clip weight to apply manually at the 12 o'clock position
	ALU BIKE	$\frac{g \times 5}{oz \times 1/4}$	adhesive weight to apply manually at the 12* o'clock position.	adhesive weight to apply manually at the 12* o'clock position.

*The machine allows the operator to change the application position of the adhesive weight from o'clock to 12 o'clock using the CLIP weight holder or 6 o'clock using the LASER line la based on his requirements.

To change the application position for the adhesive weights, follow the instructions in the set up menu "Adhesive weight application position".

3. ENTERING WHEEL DIMENSIONS (ALU1P AND ALU2P PROGRAMMES EXCLUDED)

UK

Wheel data entry for wheel balancers without outer mechanical sensor

The machine allows for the diameter and distance values to be entered automatically; the value can be entered using the keypad.

- Bring the automatic measuring arm into contact with the inner side of the rim (fig. 11).

Take great care to position the arm correctly so as to ensure accurate data reading. While moving the automatic arm, the distance measured by the arm is shown on the display:

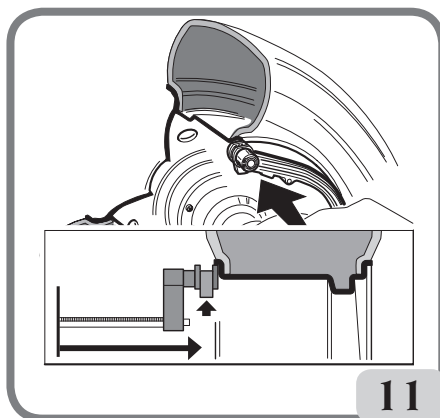

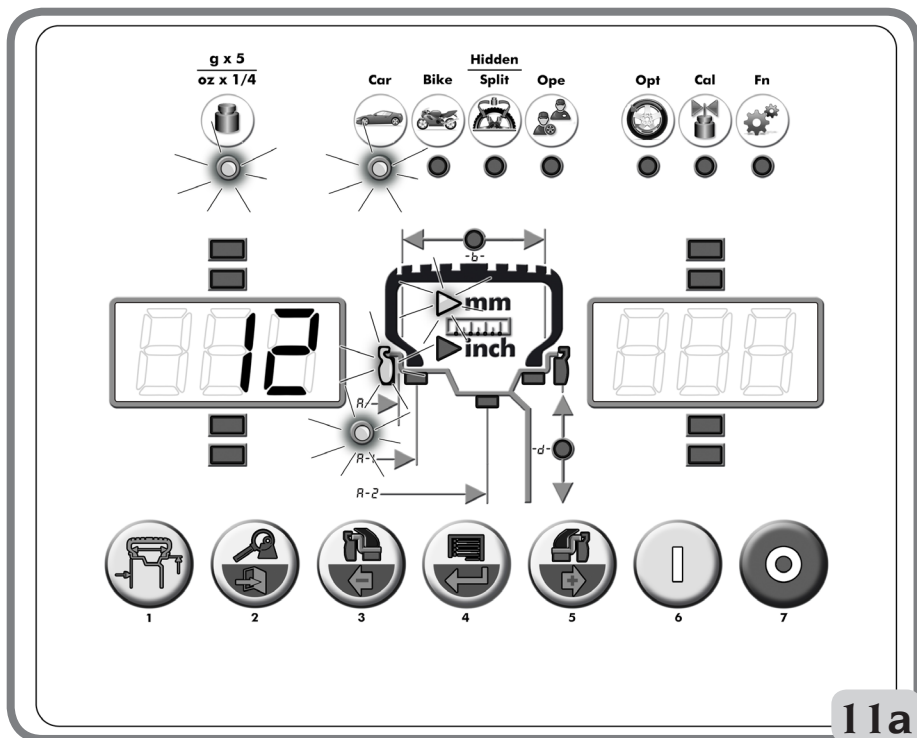

When the measurement is stored, the value of the distance acquired by the machine will remain visible on the left display:

- if only one measurement is taken, the machine interprets the presence of a rim with balancing using a clip weight on both sides (Dynamic Balancing Programme);
- moving the arm to the rest position, the machine will set up for the manual WIDTH entry;
- in this phase, it is possible to perform an additional acquisition of the rim diameter and distance.
- Measure the width of the rim using the calliper provided (fig.12).



- Modify the width value displayed by pressing the buttons until the desired value is set.

The WIDTH can be set in millimetres or the values already set can be converted from



inches to millimetres by pressing the button.



Keep the keys pressed to rapidly increase or decrease the previously set values.

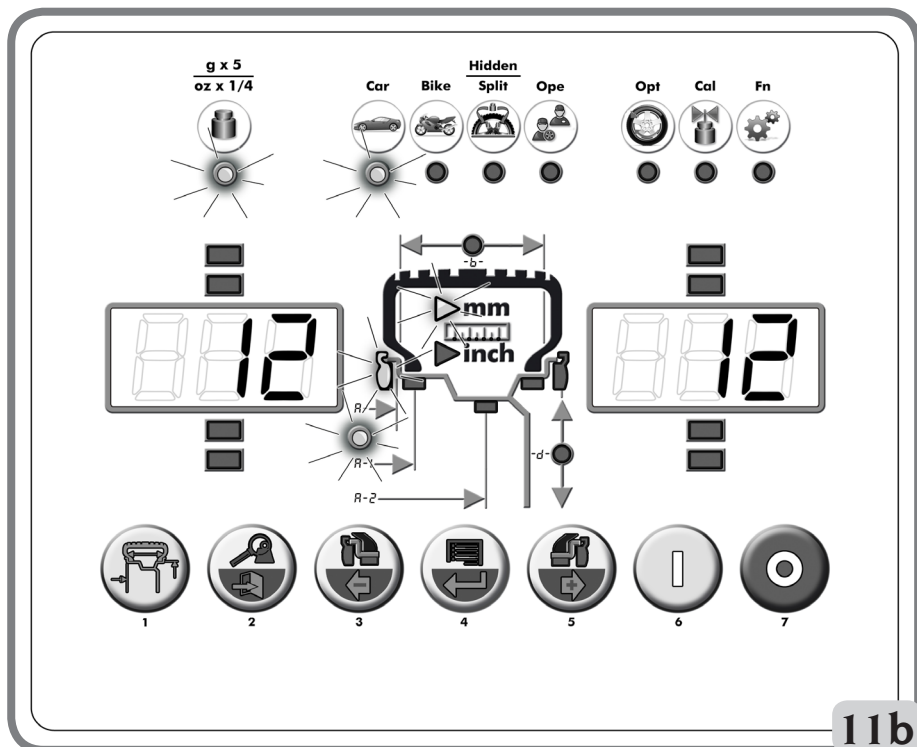

After completing the wheel data update, press the  button to exit and display the unbalance values recalculated according to the new dimensions, or to perform a wheel spin. - if two subsequent measurements are taken inside the rim on two balancing planes, the machine interprets the presence of a rim with balancing using a clip weight on the inner plane and an adhesive weight on the external one (ALU 2P).

UK

In this phase, the machine could automatically change the type of weight on the inner plane from clip to adhesive (ALU 1P). The operator is able to change this setting by pressing the



or key. In this case, the balancing programme switches from ALU 1P to ALU 2P and vice versa.

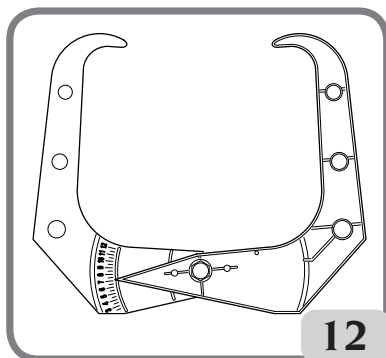

For models with automatic inner (distance and diameter) sensor and automatic and outer mechanical (width) measuring sensors

To enter the distance, diameter and width values automatically, proceed as follows:

- bring the automatic internal measuring arm (A, Fig. 8) into contact with the inner side of the rim as shown in Fig. 11 and at the same time bring the automatic external measuring arm (B, Fig. 8) into contact with the outer side Fig. 12a.

- Take great care to position the arm correctly so as to ensure accurate data reading.

- Keep the arms in contact with the rim until the machine has acquired the values.

When a geometric value is acquired, the corresponding LED illuminates on the display panel.

- Return the arm to the rest position.

- If an incorrect value has been acquired during the measurement phase, move the arms to the rest position and then repeat the operation.

Measurements can be taken also by moving one measuring arm at a time. In this case, sensors can be used with no preset order. Pay maximum attention to the measured data since they are influenced by the stored ones.

After setting geometric dimensions correctly and returning the sensors to the rest position, the unbalance values recalculated according to the new dimensions are displayed.

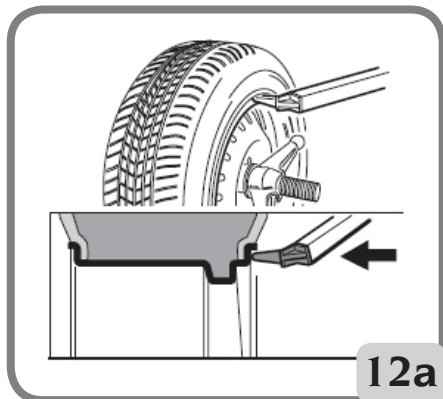

IMPORTANT

bear in mind that the wheel's rated diameter (e.g. 14") refers to the planes on which the tyre beads rest, which are obviously inside the rim. The values measured are with reference to external planes and, as a result, are smaller than the nominal values due to the thickness of the rim itself. The correction value therefore refers to an average thickness of the rim. This means that the data measured on wheels with different thicknesses may vary slightly (2 or 3 tenths of an inch maximum) from the rated values. This is not a lack of accuracy of the measuring devices, but reflects reality.

If the automatic measuring arm fails to operate, the geometrical data can be entered in manual mode by following the procedure indicated in the paragraph "entering wheel dimensions - for models with manual inner sensors (distance and diameter)".

If the inner sensor (diameter and distance) fails to operate or with the inner manual sensor

- Use the keypad to enter the wheel geometric data by following the procedure described below:

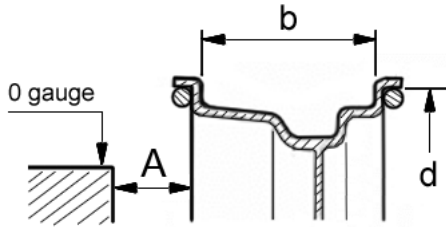

- press the button

- measure the width of the rim using the calliper provided (Fig. 12)



- modify the width value (-b-) displayed by pressing the keys until the desired value is set.



The displayed values can be increased or decreased quickly by keeping the keys



pressed.

The width can be set in millimetres by changing the setting of the unit of measurement in the machine's set-up menu.



- press the key to confirm the previous value and set the machine for diameter entry (-d-)

- read the rated rim diameter value on the tyre



- modify the displayed diameter value by pressing the keys until the read number is set



- press the key to confirm the previous value and set the machine for distance data entry (-A-)

- bring the distance measuring arm into contact with the inner side of the rim (Fig. 11)

- read the distance value between the wheel and the body on the rule (A, Fig. 13)

- modify the displayed distance value by

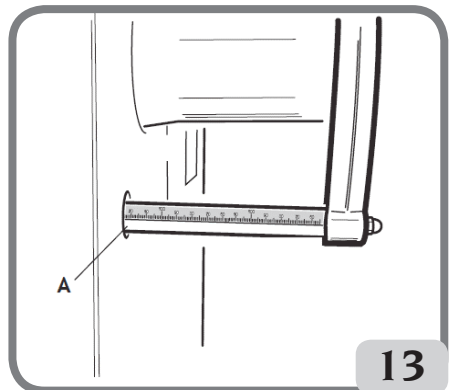



pressing the



- on completion, press



of the new dimensions, or



WARNING

If the diameter and distance values between the two balancing planes, recalculated on a statistical basis starting from the rated geometric data of the wheel, exceed the normally accepted interval stated in the technical data section, the message "A 5" is displayed.

4. ENTERING WHEEL DIMENSIONS IN THE ALU1P OR ALU2P BALANCING PROGRAMMES

With this programme the real wheel data have to be set in relation to the real balancing planes rather than the nominal values (as in standard ALU programmes). The balancing planes where the adhesive weights are to be applied may be selected by the user according to the specific shape of the rim. It should be remembered, however, that in order to reduce the quantity of the weight that is to be applied it is preferable to select balancing planes that are as far apart as possible: if the distance between the two planes is less than 37 mm (1.5"), the "A 5" message is displayed.

The various methods for inserting dimensions are described below based on the supplied devices:

WITH THE VERSION WITH AUTOMATIC SENSOR, PROCEED AS FOLLOWS:

- Move the end of the automatic measuring arm in line with the plane selected for the application of the inner weight. In Alu 1P the centre of the notch in the holder is used as the reference for the centre line of the weight (fig.14). In Alu 2P refer to the rim edge, since the inner weight is of the clip type (Fig.15).
- Keep the arm in position. After two seconds the machine emits an acoustic confirmation signal to indicate that the distance and diameter values have been acquired.
- Move the end of the automatic measuring arm in correspondence with the plane selected for the application of the outer weight (Fig. 14a/15a), in the same manner as described previously for the inner side.

Pay maximum attention when the end of the arm is being placed in an area of the rim free of discontinuity, so that the weight can be applied in that position.

- Keep the arm in position. After two seconds the machine emits an acoustic confirmation signal to indicate that the distance and diameter values have been acquired.

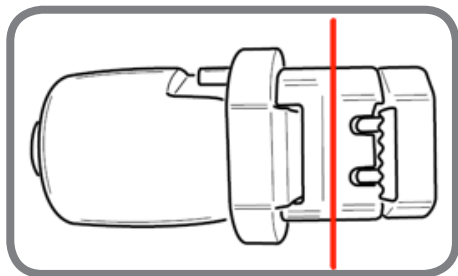

Centre of the notch in the weight holder

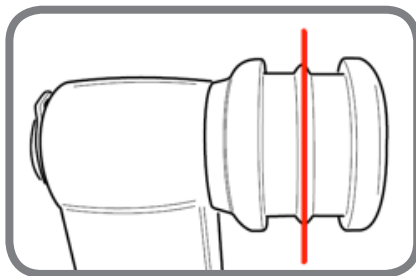

Centre of the notch in the holder without the weight holder

- Return the measuring arm to the rest position. Automatically the machine will setup in the ALUP balancing programmes (FSP programme).
- Carry out a spin.
- At the end of the spin, if you want to change the balancing programme set automatically by



the machine (FSP), select the **3** or **5** key until the required programme is selected.

IN THE VERSION WITH MANUAL SENSOR, PROCEED AS FOLLOWS:



- Press the **1** key to prepare the machine for entering distance d_1 relative to the internal side (the distance LED lights up on the panel).
- Bring the end of the measuring arm level with the plane selected for applying the internal weight (Fig. 14 for ALU 1P, Fig. 15 for ALU 2P). In Alu 1P the centre of the notch in the holder is used as the reference for the centre line of the weight. In Alu 2 P, the rim edge is taken as a reference, since the inner weight is of the conventional clip type.

Pay maximum attention when the end of the arm is being placed in an area of the rim free of discontinuity, so that the weight can be applied in that position.

- Read the internal distance d_1 from the body on the rule.



- Modify the value on the right display by pressing the **3** or **5** keys to get the previously **read distance d_1** .



- Press the **1** key again to prepare the machine for entry of the **d_2 distance** relating to the outer side (the distance LED lights up on the panel).
- Position the end of the measuring arm on the plane chosen for the application of the **outer** weight, as previously described for the inner side.
- Read the **distance d_2** from the body on the rule.



- Modify the value on the right display by pressing the **3** or **5** keys to get the previ-

ously measured distance d2.



- Press the key again to set the machine for entering the nominal wheel diameter.
- Read the rated rim diameter value on the tyre.



- Modify the value displayed on the right display by pressing the keys to get the previously measured **nominal diameter**.
- Press to display the unbalance values (recalculated according to the new dimensions) or perform a wheel spin.

ALU 1P

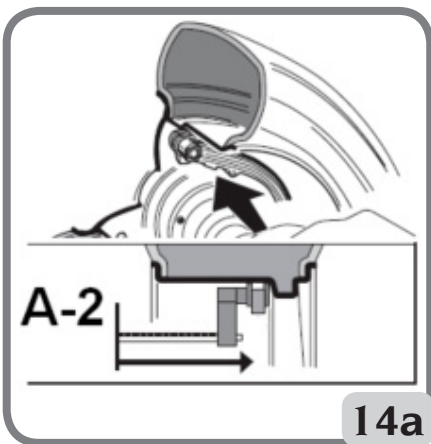
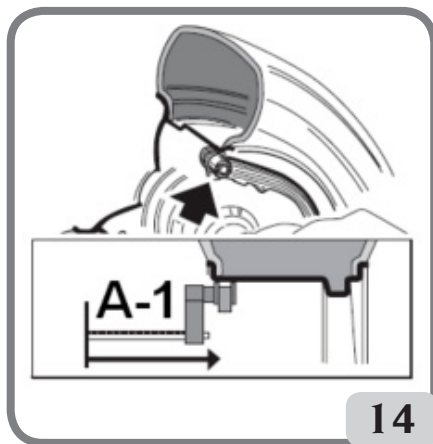

ALU 2P

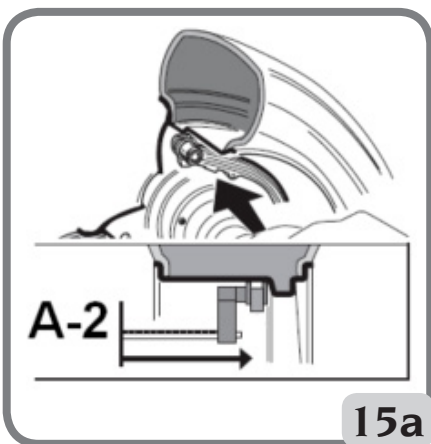
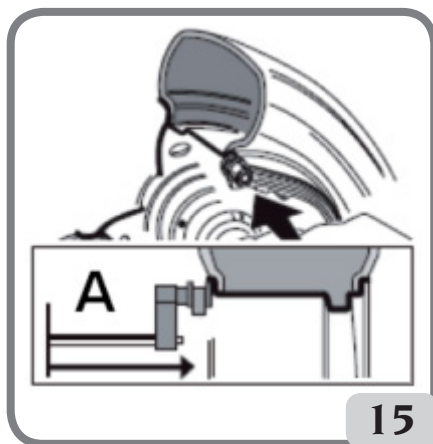

PLAN DETECTION BY LASERRAY POINTER (IF PRESENTED)

Geometry data detection for real balancing plans for the application of adhesive weights can be facilitated by the laser line on the automatic detector lever.

To enable this line, it is necessary to press the button on the automatic arm (A, Fig.15b).

The laser line remains visible inside the rim for 10 seconds, then, if necessary, press the button on the automatic arm again.

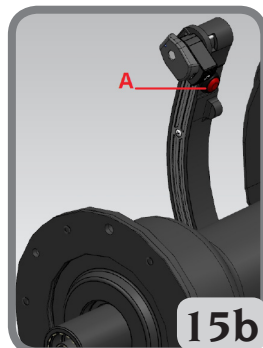

5. ENTERING DIMENSIONS IN THE MOTORCYCLE PROGRAMMES

The operations described below are valid if the motorcycle setting (byke) has been activated in the "vehicle type" set up.

- Fit the appropriate extension on the inner measuring arm, specifically extension A on machines with no weight holder or extension B on machines with weight holder (Fig.16).
- To acquire the wheel dimensions, follow the instructions in the paragraph "Entering wheel dimensions".

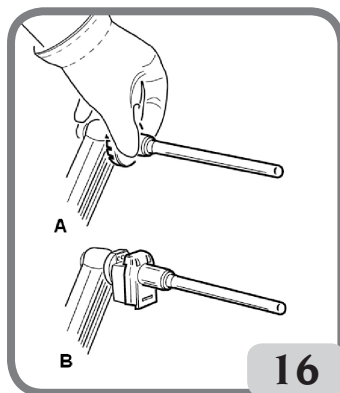

6. WHEEL SPIN



Wheel spins take place by pressing the key.

WARNING

To obtain the most accurate results, we recommend not improperly solicit the wheel balancer during the spin.



CAUTION

If the wheel keeps spinning permanently due to a fault on the machine, switch off the machine using the main switch or disconnect the plug from the power supply board (emergency stop).



If the key is pressed whilst the wheel is rotating, the spin will be prematurely interrupted.

CAUTION

During machine use, personnel may not be present in the area enclosed by the sectioning in Fig. 4.

7. UNBALANCE DISPLAY WITHOUT ROUNDING-OFF

When started up, the machine is set to display the unbalance values at five-gramme increments, i.e. rounded to the nearest multiple of five (or quarters of an ounce if visualised in ounces).

In this condition, the first four grams of unbalance are not displayed since an appropriate



threshold, indicated by illumination of the LED on the display panel, is activated.



The key can be pressed to temporarily eliminate the threshold (the LED “g x 5”; “oz x 1/4” goes out) and the unbalance values will be displayed gram by gram (or in tenths of an ounce if display in ounces is active).



CAUTION

This key is deactivated if the gram by gram unbalance display has been set in the machine set up or if the ALU1P or ALU2P balancing programme is used.

8. BALANCING WEIGHT APPLICATION

clip weights

- Select the first side to be balanced.
- Turn the wheel until the central element of the corresponding position indicator lights up.
- Apply the indicated balancing weight in the position of the rim corresponding to 12 o'clock.



CAUTION

Check that the system which fits the weight to the rim is in optimum condition. A weight which is not fitted properly or correctly may come off as the wheel rotates, thus creating a potential danger.



Pressing the button while the wheel is moving interrupts the wheel spin before time and the A STP message is displayed.

If the “RPA” (centred position) programme is active, at the end of each balancing spin the machine stops the wheel in the position for application of the weight on the outer side; if it

is equal to zero, the wheel is stopped in the inner side weight application position.



By simultaneously pressing  and , automatic search for the second side position is activated.

This function is described at length in the AUTOMATIC POSITION SEARCH section.

• **Manually applied adhesive weights**

- Select the first side to be balanced.
- Turn the wheel until the central element of the corresponding position indicator lights up.
- Apply the indicated balancing weight in the position of the rim corresponding to 12 o'clock.



WARNING

The application position of the adhesive weight can be changed from 12 o'clock to 6 o'clock by following the instructions in the set up menu "Adhesive weight application position".



WARNING

- for applying the adhesive weight in the MOTORCYCLE (ALU) programmes, always use 12 o'clock as the reference regardless of the setting in "SELECTION OF ADHESIVE WEIGHT APPLICATION POSITION".

IMPORTANT

in ALU1 and ALU2 programmes the unbalance displayed by the machine on the outer side refers to the adhesive weight centre of gravity at the swinging unit bearing flange, (Fig. 17)

• **Manually applied adhesive weights with laser device enabled (if provided)**

- Select the first side to be balanced.
- Turn the wheel until the central element of the corresponding position indicator lights up together with the laser line.
- Apply the indicated balancing weight in the position on the rim corresponding to 6 o'clock.

Some slight residual unbalances may remain at the end of the test spin due to the considerable difference in shape that may be found on rims having the same rated dimensions. Therefore modify the value and position the previously applied weights for accurate wheel balancing.

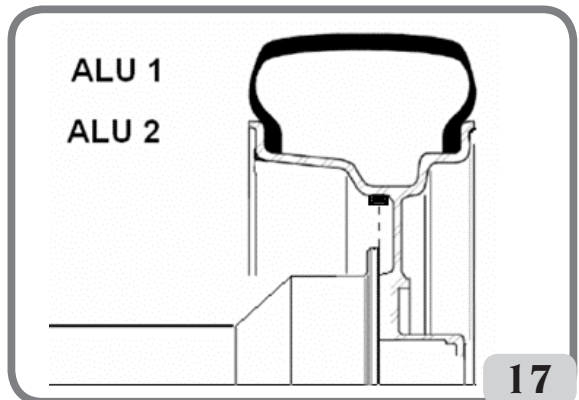

UK

9. APPLYING BALANCING WEIGHTS IN ALU1P OR ALU2P PROGRAMMES

- Adhesive weights applied with the weight-holder device (if provided) and after changing the application position from 12 o'clock with the CLIP in the "Adhesive weight application position" setup menu

- 1 Select the first side to be balanced.
- 2 Turn the wheel until the central element of the corresponding position indicator lights up. Keeping the wheel in position with the clamping brake, a display will now show the quantity of the weight to be applied in gr/ounces and the other will display the distance in mm alternatively to the plane identification abbreviation (A-1 for Inner Plane/A-2 for Outer Plane).
- 3 Position the adhesive weight inside the cavity of the weight-holder device (Fig. 18,a,b).
- 4 Remove the adhesive protective film (Fig. 18c).
- 5 **IN THE MACHINE VERSION WITH AUTOMATIC SENSOR** move the sensor until it reaches the indicated position. During this phase, the unbalance value of the side to be balanced is shown on one display, whereas the numerical value updated according to the sensor position, which becomes zero when the position for application of the weight is reached, is shown on the other display.
IN THE MACHINE VERSION WITH MANUAL SENSOR with the wheel in a centred position, the machine indicates the unbalance value on a display, whereas the other display shows the message "d1" or "d2" alternately to the distance value of the plane corresponding to the body.
Move the sensor to the position shown on the display in which the message "d1" or "d2" appears alternately to the distance value (the distance is read on the rule).
- 6 Turn the end of the measuring arm until the weight adhesive strip is in line with the rim surface.
- 7 Press the key (Fig. 18d) to eject the weight and make it stick to the rim.
- 8 Return the measuring arm to the rest position (Fig. 18e).
- 9 Repeat the operations to apply the second balancing weight.

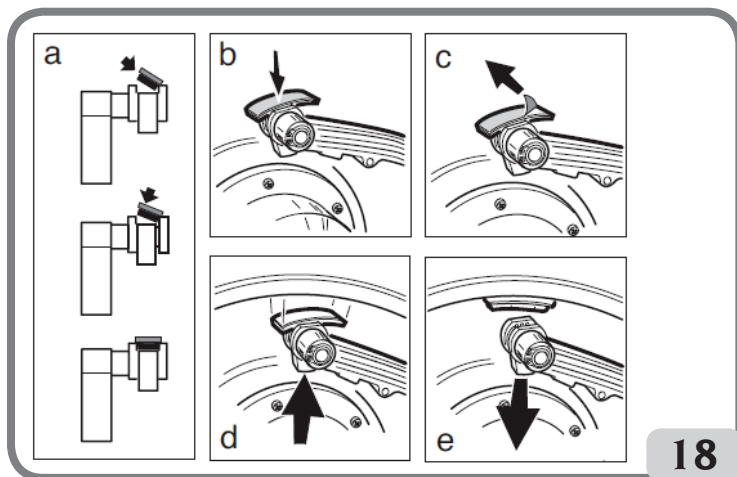

- 10 Perform a test wheel spin to check the balancing accuracy.

The rim surface must be perfectly clean to make the weight stick efficiently to the rim. If necessary, clean the surface using suitable cleansing products.

- **Manually applied adhesive weights**

- 1 Select the first side to be balanced
- 2 Turn the wheel until the central element of the corresponding position indicator lights up.
- 3 Apply the adhesive weight manually in the position in which the relative plane was measured, using the centre of gravity of the weight itself as reference. In this phase, one display shows the unbalance value of the side to be balanced and the other shows the message "H.12" that indicates the correct position of application as shown in figure 19.



WARNING

The machine allows the operator to select the method for applying the CLIP adhesive weight at 6 o'clock (if the laser indicator is present) based on his requirements. To change the application position for the adhesive weights, follow the instructions in the set up menu "Adhesive weight application position".

- **Manually applied adhesive weights with laser device enabled (if provided)**

- 1 Select the first side to be balanced.
- 2 Turn the wheel until the central element of the corresponding position indicator lights up together with the laser line.
- 3 Apply the adhesive weight manually in the position in which the relative plane was measured, using the centre of gravity of the weight itself as reference. In this phase, one display shows the unbalance value of the side to be balanced and the other shows the message "H.6" that indicates the correct position of application as shown in figure 19.

- **Adhesive weights applied manually without the weight-holder device (CLIP adhesive weight application position enabled)**

- 1 Select the first side to be balanced.
- 2 Turn the wheel until the central element of the corresponding position indicator lights up. Keeping the wheel in position with the clamping brake, a display will now show the quantity of the weight to be applied in gr/ounces and the other will display the distance in mm alternatively to the plane identification abbreviation (A-1 for Inner Plane/A-2 for Outer Plane).
- 3 **IN THE MACHINE VERSION WITH AUTOMATIC SENSOR** move the sensor until it reaches the indicated position. During this phase, the unbalance value of the side to be balanced is shown on one display, whereas the numerical value updated according to the sensor position, which

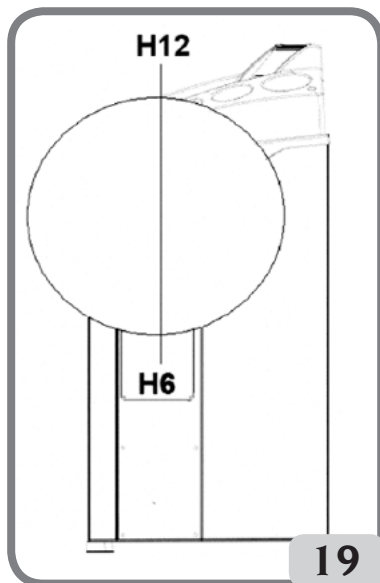

UK

becomes zero when the position for application of the weight is reached, is shown on the other display.

IN THE MACHINE VERSION WITH MANUAL SENSOR with the wheel in a centred position, the machine indicates the unbalance value on a display, whereas the other display shows the message "d1" or "d2" alternately to the distance value of the plane corresponding to the body.

Move the sensor to the position shown on the display in which the message "d1" or "d2" appears alternately to the distance value (the distance is read on the rule)

- 4 Apply the adhesive weight manually, using the centre of the notch in the holder as the reference for the centre line of the weight.

"Shift planes" programme (only with ALU P programmes)

This function is automatically enabled when an ALU P programme is selected.

It modifies the former selected positions for the application of adhesive balancing weights, in order to allow perfect wheel balancing using commercially available adhesive weights in multiples of five grams.

The accuracy of the machine is thereby improved, avoiding rounding-off or cutting the weights to be applied to come closer to the actual unbalance values.

10. PROGRAMME FOR POSITIONING THE WEIGHTS BEHIND THE SPOKES "HIDDEN WEIGHT" (ONLY WITH ALU 1P AND ALU 2P PROGRAMMES)

For alloy wheels, use the Hidden Weight programme in conjunction with the ALU 1P or ALU 2P programme to conceal the external weight behind two spokes for aesthetic reasons.

The Hidden Weight programme can only be activated if there is an unbalance on the outside.

This programme divides the outer weight P_e into two weights P_1 and P_2 located in any position chosen by the operator. The only condition is that the two weights and the original outer weight P_e must be within an angle of 120° , as shown in Fig. 20.

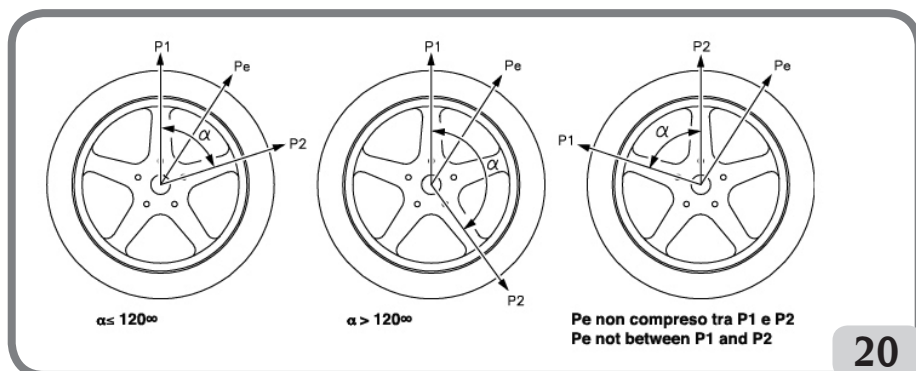



Figure 20. Conditions necessary for using the Hidden weights programme

To use this programme, proceed as follows:

- 1 Turn the wheel until the central element of the corresponding position indicator lights up.

It is recommended to keep the wheel in position using the pedal brake.



- 2 Press the  key to activate the programme.

Programme activation is indicated by the illumination of the LED  on the display panel.

- 3 If the weight-holder device is present, turn the wheel again until the central element of the outer side (Pe) position indicator lights up.
- 4 Turn the wheel to the point where the first outer weight (P1) should be applied behind a spoke. The machine will display the following message:



To select the exact position of the weight P1 relative to the Pe unbalance, use 6 o'clock as the reference if the "LAS" configuration is active and 12 o'clock if the "H12" or "CLP" configuration is active.

The angle between P1 and Pe must be less than 120°.



- 5 Press the  key to memorise the first spoke.

- 6 Turn the wheel to the point where the second outer weight (P2) should be applied behind a spoke. The machine will display the following message:



To select the exact position of the weight P2 relative to the Pe unbalance, use 6 o'clock as the reference if the "LAS" configuration is active and 12 o'clock if the "H12" or "CLP" configuration is active.

The angle between P1 and P2 must be less than 120° and must include the outer weight Pe.



- 7 Press the  key to memorise the second spoke.

- 8 Turn the wheel manually and the two unbalance values calculated are displayed in alternation on the display regarding the outer side as the angular position of the wheel changes. Each of the two balancing weights is applied as described in the chapter



"Applying balancing weights in ALU1P or ALU2P balancing programmes".
 The Hidden Weight function is combined with the SHIFT PLANES function to allow the use of balancing weights in multiples of 5 grams

Notes:



- The Hidden Weight procedure can be quit at any time by simply pressing the  key.
- The Hidden Weight procedure is automatically deactivated by performing a wheel spin.

11. PROGRAM FOR SPLITTING THE WEIGHT ON EITHER SIDE OF THE SPOKE “SPLIT WEIGHT” (ONLY WITH MOTORCYCLE PROGRAMMES)

Some rims have spokes so wide that it is not possible to place adhesive weights next to them; for this reason, the Split Weight programme divides the counterweights into two parts.

To use this programme, proceed as follows:

- Turn the wheel until the central element of the external side position indicator lights up. It is recommended to keep the wheel in position using the pedal brake





- Press the  key to activate the programme.



Programme activation is indicated by the illumination of the LED  on the display panel.



- Use the   keys to select the spoke width
 - 1 **small**
 - 2 **medium**
 - 3 **large**
- OFF deactivates the programme;**



- Confirm with the  key.
- Apply two new counterweights in the positions indicated.

In the motorcycle balancing programmes, the weight division operation can be performed on both balancing sides.

12. UNBALANCE OPTIMISATION PROGRAMME "OPT"

This procedure minimises any vibration still present on the vehicle while running even after accurate balancing, thus minimising the rim-tyre coupling run-out.

Based on our experiences, the programme can be recalled every time it is convenient to minimise the running noise produced by the vibrations mentioned above.

The calculations performed by this programme are based on the unbalance values measured during the last spin performed which must therefore refer to the wheel being serviced.



- Press the  key.

- Use the   keys to search for OPT.

- Press the  key to activate the optimisation procedure.



Programme activation is indicated by the illumination of the LED  on the display panel.

OPERATING PHASES	
OP.1 H.12	- bring the valve to the "12 o'clock" position and press  to confirm
OP.2 180	- make a mark on the tyre 180° from the valve - remove the wheel from the wheel balancer - go to the tyre changer and move the mark made in correspondence with the valve - press the  key to confirm.
OP.3 H.12	- remount the wheel on the wheel balancer - move the valve to the 12 o'clock position - press the  key to confirm.
OP.4	- perform a spin



OPERATING PHASES

OP.5

- turn the wheel until it is in the position shown by the position indicators
- use chalk to make a double mark on the outer side of the tyre at the 12 o'clock position



Note: in this phase, press the **1** key to display: the first time the key is pressed, the actual unbalance values of the wheel as currently mounted on the wheel balancer; the second time the key is pressed, the obtained unbalance value continuing with the last phase of the optimisation procedure with the improvement percentage; when the key is pressed for the third time, the machine prepares for the last phase of the OPT programme

- remove the wheel from the wheel balancer
- on the tyre changer, move the double mark made in correspondence with the valve



- press the **4** key to confirm and end the unbalance optimisation procedure.

Notes:



- The unbalance optimisation procedure can be quit at any time by pressing the key; the displays will show the premature exit message:



Press the **4** key to exit or the **2** key to stay in the programme.

- The following message could be displayed at the end of the first spin:

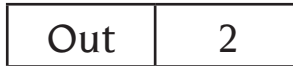

In this case it is advisable to exit the programme by pressing the key: **2** the values of the weights necessary for balancing the wheel are displayed. The programme execution is interrupted, thus not achieving the moderate improvement of the end results. By



pressing the **5** key the optimisation procedure can be continued.

- At the end of the first spin the instruction that the tyre is to be mounted on the rim in the reverse direction may appear. If you do not intend to reverse the tyre or if doing so



is impossible, press the  key and the machine will provide the instructions for completing the programme without reversing the tyre.

13. ENABLING THE OTHER OPERATOR

This programme makes it possible for two different operators to use the machine at the same time due to the presence of two different working environments.

The parameters which remain saved for every working environment are:

- balancing mode (Dynamic, Alu x, Motorcycle etc.);
- wheel dimensions (distance, diameter and width of those relating to the active ALU programme).

The machine's general settings remain the same for all working environments:

- grams/ounces, sensitivity x1/x5, threshold, etc....

Proceed as follows to recall this programme:



- press the  key



- use the   keys to search for OPE 1 (or OPE 2 if previously set)



- press the  key to change the setting:
1 first operator
or 2 second operator



- press the  key to confirm and exit.









Activation of the second operator is indicated by the illumination of the LED  on the display panel.

Repeat the procedure described above to return to the first operator.

14. WHEEL SPIN COUNTER

This programme is used to display the total number of spins performed by the machine since its first start-up (**tot SPI**), the number of spins performed since the last unbalance calibration (**CAL SPI**) and the number of partial spins performed since the machine was last started (**PAr SPI**).

Proceed as follows to recall this programme:





- press the  key
- use the   keys to search for **-SP in-**
- press the  key to display the total number of spins performed by the machine since its first start-up (**tot SPi**)
- press the  key to display the number of spins performed since the last sensitivity calibration (**CAL SPi**). It is reset at each new calibration
- press the  key to display the number of spins performed since the last sensitivity calibration (**PAR SPi**). It is reset each time it is turned off
- press the  key to exit.

15. GENERAL CONFIGURATIONS - SET UP

The machine can be configured according to your requirements. The following configurations are available:









- **Selecting vehicle type (car – motorcycle)**
- **Selecting the mode for acquiring wheel dimensions in the ALU1 and ALU2 balancing programmes (ONLY the version with manual sensor)**
- **Unbalance unit of measurement**
- **Unbalance rounding-off**
- **Automatic position search (RPA)**
- **Warning OPT**
- **Rim diameter display unit of measurement**
- **Rim width display unit of measurement**
- **Acoustic signal**
- **Setting - Adhesive weight application position (CLIP - LASER h6-h12)**
- **Display brightness setting**
- **LED light (if provided)**
- **Laser indicator (if provided)**

Proceed as follows to access the configuration menu:

- press the  key
- use the   keys to search for SEt UP
- press the  key.

15.1. SET UP - SELECTING VEHICLE TYPE (CAR-MOTORCYCLE)

Configuration used for enabling motorcycle wheel balancing functions.
Proceed as follows to recall this programme:

- press the  key
- use the   keys to search for SEt UP
- press the  key to confirm
- use the   keys to search for CAR on
(or CAR off if previously set)
- press the  key to change the setting:
CAR on to activate the car working environment
CAR off to activate the motorcycle working environment
- press the  key to confirm and exit.

Warning

Proceed as follows to balance a motorcycle wheel:
- fit the motorcycle wheel adapter A on the wheel balancer as shown in Fig. 21;

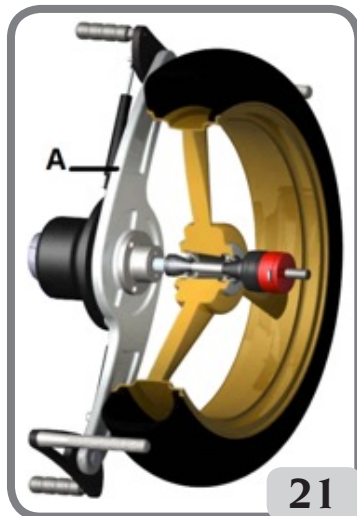

21

UK

- remove the hub;
- insert the two screws that are supplied in the holes on the wheel contact flange;
- tighten the screws on the adapter making sure that it rests on the flange correctly;
- montare l'albero da moto sull'adattatore;
- mount the wheel after selecting the centring cones (one for each side of the wheel), tighten with the appropriate ring nut using the spacers necessary for coupling the securing cones to the threaded part of the shaft.
- mount the relative extension (Fig.22) on the internal measuring arm.
- set the wheel data as shown in the paragraph "Entering wheel dimensions".

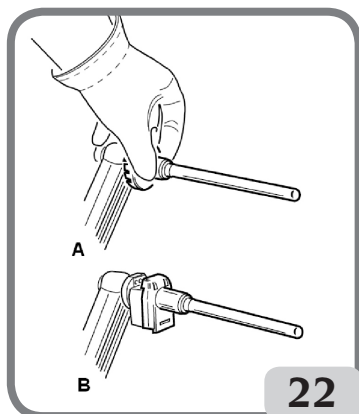



Important

the wheel must be fixed to the flange so as to avoid any movement of the two during the spin or braking phases.



Best results can be achieved if the adhesive weights are positioned with the outer edge flush with the rim edge.

15.2. SET UP – SELECTING THE MODE FOR ACQUIRING WHEEL DIMENSIONS IN THE ALU1 AND ALU2 BALANCING PROGRAMMES (ONLY THE MACHINE VERSION WITH MANUAL SENSOR)

This configuration is used to select the method for entering dimensions for the ALU1 and ALU2 programs and as a result the method of applying the adhesive weights inside the rim. Proceed as follows to recall this programme:

- press the  key
- use the   keys to search for **SET UP**

- press the  key to confirm

- use the   keys to search for ALU P (or ALU St if previously set)



- press the  key to change the setting:

or **ALU P:** to activate the ALUP balancing programmes. These programmes are used for maximum precision balancing on light aluminium rims that require the application of both weights on the same side (inner) in relation to the rim disk. This type of wheel balancer is particularly suitable for application of adhesive weights on the rim, thanks to the forward position of the wheel in relation to the body, which allows a large zone on the inside of the rim to be accessed freely. To enter the dimensions and apply the weights, refer to the paragraphs with ALU 1P – ALU2P

or **ALU St:** to memorise the rated dimensions of the rim. Self-adhesive weights are generally used to balance alloy wheels and are applied differently than for standard balancing. Several ALU balancing programmes are available, specially designed for these types of rim. To enter the dimensions and apply the weights, refer to the paragraphs “Entering wheel dimensions (ALU 1P and ALU2P programmes excluded)” and “Applying balancing weights”



- press the  key to confirm and exit.

15.3. SET UP - UNBALANCE UNIT OF MEASURE

The machine may be set to display the unbalance values in grams or ounces. Proceed as follows to modify this configuration:



- press the  key





- use the   keys to search for SET UP



- press the  key to confirm



- use the   keys to search for Unb Gr (or Unb Oun if the ounce display mode is active)



- press the  key to change the setting:

Unb Gr to activate the unbalance display in grams
or Unb Oun to activate the unbalance display in ounces





- press the  key to confirm and exit.

It is possible to quickly set the unit of measure in grams or ounces by pressing and hold-



ing the  key for at least six seconds

15.4. SET UP - UNBALANCE ROUNDING-OFF

The machine may be set to display the unbalance values in five-gramme increments i.e. rounded to the nearest multiple of five (or quarters of an ounce if displayed in ounces) or rounded to the gram (or tenth of an ounce if displayed in ounces).

Proceed as follows to modify this configuration:



- press the  key





- use the   keys to search for SET UP



- press the  key to confirm



- use the   keys to search for Gr 5 (if the gram display mode is activated) or Oun 0.25 (if the ounce display mode is activated)



- press the  key to change the setting:

Gr 1 to activate the unbalance display rounded to the gram

or Gr 5 to activate the unbalance display rounded to the nearest multiple of five

If the ounce display mode is active

or Oun 0.25 to activate the unbalance display rounded to a quarter of an ounce

Oun 0.10 to activate the unbalance display rounded to a tenth of an ounce



- press the  key to confirm and exit.

15.5. AUTOMATIC POSITION SEARCH (RPA)

When the automatic position search programme is activated, the machine stops the wheel in the position for application of the outer side weight at the end of every balancing spin; if it is equal to zero, the wheel is stopped in the inner side weight application position.



Press the  button to search for the second side position with the guard raised. Proceed as follows to deactivate the automatic position search programme:



- press the  key



- use the  keys to search for SET UP





- press the  key to confirm



- use the  keys to search for rPA on (rPA OFF if previously set)



- press the  key to change the setting:
or rPA on  to enable the automatic position search programme
or rPA OFF  to disable the automatic position search programme



- press the  key to confirm and exit.



15.6. SET UP - WARNING OPT

The machine indicates the need to perform an unbalance optimisation procedure (OPT) with the flashing LED on the display panel.

Proceed as follows to disable this function:



- press the  key







- use the  keys to search for SET UP



- press the  key to confirm
- use the keys to search for OPT on (OPT OFF if disabled)



- press the   key to change the setting:
OPT on  to activate the display of the alarm indicator light
or OPT OFF  to deactivate the display of the alarm indicator light



- press the  key to confirm and exit.

15.7. SET UP - RIM DIAMETER DISPLAY UNIT OF MEASUREMENT

The machine may be set to display the rim diameter unit of measurement in inches or millimetres.

Proceed as follows to modify this configuration:



- press the  key





- use the   keys to search for SET UP





- press the  key to confirm



- use the   keys to search for -d- in (-d- MM if the display in millimetres is enabled)



- press the  key to change the setting:
-d- MM  to activate the display in millimetres
or -d- in  to activate the display in inches











- press the  key to confirm and exit.

15.8. SET UP - RIM WIDTH DISPLAY UNIT OF MEASUREMENT

The machine may be set to display the rim width unit of measurement in inches or millimetres.





Proceed as follows to modify this configuration:

- press the  key
- use the   keys to search for SET UP
- press the  key to confirm
- use the   keys to search for -b- in (-b- MM if the display in millimetres is enabled)
- press the  key to change the setting:
 - b- MM to activate the display in millimetres
 - or -b- in to activate the display in inches
- press the  key to confirm and exit.





15.9. SET UP – ACOUSTIC SIGNAL

The machine can be configured to beep each time a key is pressed on the keypad.

Proceed as follows to modify this configuration:







- press the  key
- use the   keys to search for SET UP
- press the  key to confirm

UK

- use the   keys to search for biP on (biP OFF if the beeper is disabled)
- press the  key to change the setting:
biP on to activate the beeper
or biP OFF to deactivate the beeper
- press the  key to confirm and exit.

15.10. SET UP - ADHESIVE WEIGHT APPLICATION POSITION





The machine makes it possible for the operator to select where the adhesive weight should be applied based on his needs. To select this configuration, proceed as described below:

- press the  key
- use the   keys to search for SET UP
- press the  key to confirm
- use the   keys to search for ALU H.12 (ALU CLP – ALU H.6 using the LASER line if present)
- press the  key to change the setting:

TYPE OF WEIGHT TO BE APPLIED	CONFIGURATION SELECTED	WEIGHT APPLICATION POSITION
Traditional clip		Always 12 o'clock
Adhesive MOTORCYCLE programme		Always 12 o'clock
Adhesive	H.12	12 o'clock in all balancing programmes

TYPE OF WEIGHT TO BE APPLIED	CONFIGURATION SELECTED	WEIGHT APPLICATION POSITION
Adhesive	LAS (if applicable)	TABLE A
Adhesive	CLP	using the weight-holder terminal in the ALU1P/ALU2P balancing programmes, or manually, taking the centre of the gripper cavity as your reference for the midway point of the weight, or using the 12 o'clock position for ALU Statistics programmes
Adhesive	H.6 (failure laser)	TABLE A

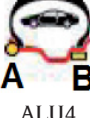
TABLE A

Type Balancing Program	Adhesive weight application position Plan A	Adhesive weight application position Plan B
 ALU1 / ALU 1P	H6 or LASER	H6 or LASER
 ALU2 / ALU 2P	H12	H6 or LASER
 ALU3	H6 or LASER	H12
 ALU4	H12	H12
 ALU5	H6 or LASER	H12

UK

Type Balancing Program	Adhesive weight application position Plan A	Adhesive weight application position Plan B
 STATIC		H6 or LASER











- press the  key to confirm and exit.

15.11. SET UP - BRIGHTNESS DISPLAY SETTING

The machine allows the operator to change the brightness of the display according to your needs.

To do this, you must:

- Press the button  4
- Use the buttons  3  5 to search for SET UP
- Press the button  4 to confirm
- Use the buttons  3  5 to search for dSP -3- (factory setting)
- press the button  4 to change the setting:
 - 1 - Minimum display brightness value
 - 8- maximum display brightness value
- press the button  2 to confirm and exit.

15.12. SET UP - LED LIGHT (IF AVAILABLE)

The machine allows the operator to disable or modify the lighting mode.

Proceed as follows to make these settings:

- press the  button

- use the   keys to search for SEt UP

- press the  key to confirm

- use the   keys to search for LEd 1 (LEd 2 or LEd off if previously set)

- press the  key to change the setting:

LEd off to disable the lighting device
or LEd 1 to activate the lighting device when acquiring dimensions during an ALU1

P or ALU2 P balancing programme, at the end of a spin cycle in the case of residual unbalances for 30 seconds, in CP (centred position) for an additional 30 seconds

or LEd 2 in this configuration, the light will turn on, in addition to the situations indicated above (in the Led 1 mode) also during the entire measurement cycle, when acquiring dimensions in all balancing programmes and in the Hidden Weight programme when selecting the two planes behind the spokes.

- press the  key to confirm and exit.

15.13. SET UP - LASER INDICATOR (IF AVAILABLE)





The machine allows the operator to enable or disable the laser device.

Proceed as follows to make this setting:

- press the  key

- use the   keys to search for SEt UP

UK

- press the  key to confirm
- use the   keys to search for LAS on (LAS off if previously set)
- press the  key to change the setting:
LAS on to enable the laser device
or LAS off to disable the laser device
- press the  key to confirm and exit.







Caution

If the laser indicator is enabled, the application of the adhesive weights (except for the ALU1 P and ALU2 P balancing programs with the weight-holder device present) and the reference for selecting the two weights behind the spokes (Hidden Weight) is at 6 o'clock (H.6).

16. UNBALANCE CALIBRATION WITH CALIBRATION WEIGHT

This programme allows sensitivity calibration whenever calibration when it appears to be out of the tolerance range or when the machine requires this procedure to be performed by displaying the E 1 error message.

Proceed as follows to recall this programme:

- press the  key
- use the   keys to search for Unb CAL
- press the  key to perform calibration, proceeding as follows:

1. Fit a wheel of average dimensions (diameter no less than 14") on the wheel balancer with preferably only a small unbalance.

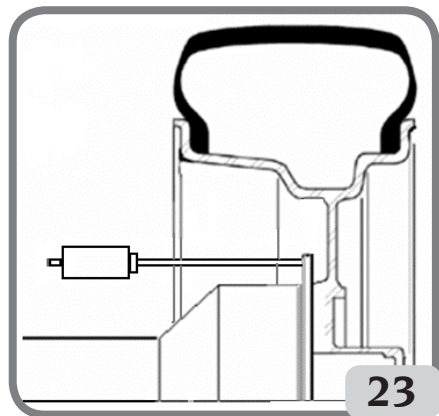

2. The machine will display the following message:

- CAL on the left-hand display;
- GO on the right-hand display.

3. Perform a first spin.

4. At the end of the spin, fix the calibration weight supplied with the machine on the shaft assembly bell as indicated in figure 23.

5. Perform a second spin.

6. At the end of the spin, change the position of the calibration weight on the swinging unit bell as indicated in figure 24.

7. Perform a third spin. This last calibration phase includes the execution of three consecutive spins in automatic mode.

At the end of the spin (the message "End CAL" will appear on the display), if the calibration has been successful, an acoustic consent signal goes off at the end of the spin otherwise the message E 2 is temporarily displayed.

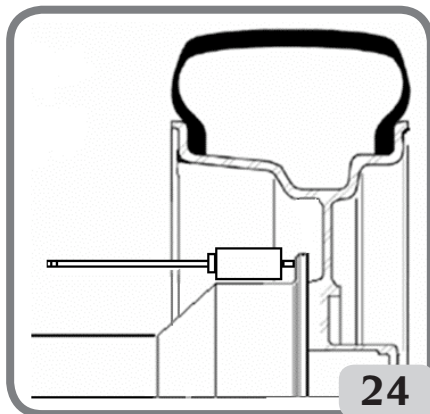

NOTES

- Once the procedure is finished, remove the calibration weight.



- Pressing the key , it is possible to interrupt the programme at any time.

- **THIS CALIBRATION IS VALID FOR ANY TYPE OF WHEEL!**

17. EXTERNAL MECHANICAL SENSOR CALIBRATION (IF INSTALLED)

UK

This programme is used to calibrate the width sensor potentiometer. It must be performed when the machine requests it by displaying the E4 message, or when the measured and the actual rim widths differ.

Proceed as follows to recall this programme:

• press the  key

• use the   keys to search for GAU CAL

• press the  key to perform calibration, proceeding as follows:

1. The machine will display the following message:

- CAL on the left display

- E flashing on the right display
2. Bring the automatic sensor arm into contact with the wheel contact flange as shown in Fig.25.

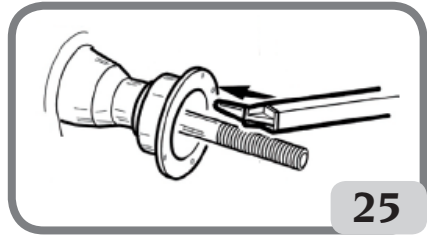

3. Press the key  to confirm the sensor position.
4. Return the arm to the rest position

Notes:

If the calibration has been carried out successfully, a confirmation message will be displayed. If the A20 message is displayed, the sensor position in the calibration phase is not correct. Position it correctly, as already described, and repeat the procedure.



- Pressing the key , it is possible to interrupt the programme at any time.

18. MESSAGES ON THE DISPLAYS

The machine can recognise a certain number of malfunction conditions and signals them to the user by visualising the relevant messages on the displays.

– A – Notice Messages

- A 3** Wheel not suitable for performing the sensitivity calibration, use a wheel of average dimensions (typically 5.5"X14") or larger, but NOT exceeding a weight of 40kg.
- A 5** Incorrect dimension settings for an ALU programme. Correct the set dimensions.
- A 7** The machine is temporarily unable to select the requested programme. Perform a wheel spin, then repeat the request.
- A 10** Internal sensor not in the rest position. Return the sensor to the rest position (completely in). If the message does not disappear, internal sensor operation







can be disabled by pressing the  button.

- A 20** Sensor in an incorrect position during calibration. Bring it to the position indicated and repeat the calibration.
- A 26** Programme available only after selecting one of the following programmes: ALU 1P / ALU 2P / Motorcycle Dynamic / Motorcycle ALU or if selected in the Motorcycle Programme but with the wheel NOT in the centred position.
- A 41** Contact the technical support centre.
- A Stp** Wheel stop during the spin phase. Wheel movement is not integral with swinging unit movement: Check correct wheel tightening.





A Cr Contact the technical support centre.

– E – Error messages

- E 1 Absence of sensitivity calibration.
Perform the sensitivity calibration procedure.
- E 2 Error condition during sensitivity calibration.
Repeat sensitivity calibration paying attention to the first spin, which must be performed with the wheel as in the successive spins.
Take particular care NOT to knock the machine during calibration.
- E 3 I/E 2/3 Error condition at the end of sensitivity calibration. Repeat the calibration, if the message persists perform the following checks:
Correct sensitivity calibration procedure;
Correct fastening and position of the calibration weight;
Mechanical and geometric condition of the calibration weight;
geometry of the wheel used.
- E 4 a) External mechanical sensor calibration error condition. Perform the external mechanical sensor calibration procedure.
b) if the error continues after calibrating the external sensor or the external sensor is not present, or there is a distance-diameter measuring sensor fault, call the technical support centre.
- E 6 Error condition when executing optimisation programme.
Repeat the procedure from the beginning.
- E 12 a) Mechanical width sensor not in the rest position when machine was switched on. Switch off the machine, return the sensor to the correct position and switch back on. If the error persists, call in the technical support centre.
b) External sensor not present or faulty. Visualisation of this error can be disabled by performing the following procedure:
- press the  key
 - use the   keys to search for GAU CAL
 - press the  key.
- E 27 **Excessive braking time. If the problem persists, contact the technical support centre.**
- E 28 Encoder counting error. If the error occurs frequently, call in the technical support centre.
- E 30 Wheel spin device failure. Switch off the machine and call in the technical support centre.
- E 32 The wheel balancer has been jolted during the reading phase. Repeat the wheel spin.
- E F0 Error in reading the 0 notch.



19. OTHER MESSAGES

OP.1	- This message indicates the valve of the wheel that must be brought to the 12 o'clock position during phases 1 and 5 of optimisation (OPT).
OP.2 180	- This message indicates that the position of the valve must be moved 180° with respect to the previous position (12 o'clock).
Out 2	- This message is displayed when the improvement obtained by optimisation is not sufficient.  2  5 - Press the 2 key to exit the program or the 5 key to continue the optimisation phase.
Abort	- Notice PREMATURE EXIT from the unbalance optimisation program.  4  2 - Press the 4 key to confirm or the 2 key to remain in the programme.
--1- -1--	- Notice TYRE MOUNTING INVERSION ON THE RIM in the OP.5 phase of the programme. If you do not want to (or cannot) carry out this operation, press the  5 key. the machine will provide the instructions to complete the programme without inversion.
HiddenEn	- This message indicates that the operator is in the "positioning the weights behind the spokes Hidden Weight" programme.
no no	- This message is displayed if the wheel is balanced on the outer side.
in -1-	- This message indicates that the machine is set for acquiring the P1 position behind the first spoke
in -2-	- This message indicates that the machine is set for acquiring the P2 position behind the second spoke.
no -2-	- This message is displayed for approx. 3 seconds if the selected angle is greater than 120 degrees, indicating that the procedure must be repeated correctly.
in H.X	- This message indicates the reference for acquiring the two points P1 and P2 behind the spokes. Depending on the configuration performed by the operator, the message on the display can be H3, H6 or H12. If the laser indicator is enabled, the reference will be 6 o'clock (H.6).
CAL GO	- Calibration spin.
I - - CAL	- This message indicates the correct position for applying the calibration weight in the unbalance calibration programme at the end of the first spin.

-- I	CAL	- This message indicates the correct position for applying the calibration weight in the unbalance calibration programme at the end of the second spin.
End	CAL	- This message indicates the end of the unbalance calibration programme.
GO	ALU	- Spin with ALU programme selected.
GO	d15	- Spin with Motorcycle Dynamic programme selected.
GO	A15	- Spin with Motorcycle ALU programme selected.
St		- Spin with Static programme selected (car/motorcycle environment) or when the Static balancing programme is selected in the vehicle working environment.
St	biE	- This message indicates the selection of the Static balancing programme in the motorcycle working environment.
dyn	biE	- This message indicates the selection of the dynamic balancing programme in the motorcycle working environment.
ALU	biE	- This message indicates the selection of the ALU balancing programme in the motorcycle working environment.
ccc	ccc	- Unbalance values greater than 999 grams.
---	A-1	- This message indicates the Inner Plane for applying the adhesive weight in the ALU1P balancing programme
A-2	---	- This message indicates the External Plane for applying the adhesive weight in the ALU1P/ALU2P balancing programme

CHECK FOR CORRECT FUNCTIONING OF BALANCING ACCESSORIES

UK

Checking balancing accessories allows the operator to make sure that wear has not altered the mechanical specifications of flanges, cones, etc. beyond the specified limits. A perfectly balanced wheel, which has been disassembled and reassembled in a different position, should not show an unbalance value greater than 10 grams.

When a higher unbalance is found, check all the accessories carefully and replace the components that are not in perfect condition (e.g. showing dents, abnormal wear, flange unbalance, etc.).

Anyway it is necessary to bear in mind that, if the cone is used to centre the wheel, satisfactory balancing results cannot be achieved if the central hole of the wheel is out-of-round or incorrectly centred; Better results can be achieved by centring the wheel using the securing holes.

Bear in mind that any re-centring error made when the wheel is mounted on the car can be removed only removed with an "on-the-vehicle balancing" of the wheel, using an on-the-vehicle wheel balancer to complement the work of the wheel balancer.

TROUBLESHOOTING

Below is a list of faults that may occur and that the user can solve if the cause is found among those indicated.

For any other malfunction or fault call in the technical support centre.

The machine does not switch on (the displays remain switched off)

No power at the socket.

- ➔ Check the mains voltage is present.
- ➔ Check the electrical power circuit in the workshop.

The machine plug is defective.

- ➔ Check that the plug is undamaged.

One of the FU1-FU2 fuses of the rear electrical panel has blown

- ➔ Replace the blown fuse.

The diameters and width values measured with the automatic measuring devices do not match the rated values of the rims.

The sensors have not been positioned correctly during measurement.

- ➔ Bring the sensors to the position shown in the manual and follow the instructions in the WHEEL DATA ENTRY section.

The external mechanical sensor has not been calibrated.

- ➔ Carry out the sensor calibration procedure. See warning instructions at the end of the EXTERNAL MECHANICAL SENSOR CALIBRATION section.

The automatic measuring devices are not working



The sensor was not in the rest position at switch-on (A 10) and the key has been pressed to enter the wheel geometric data with the keypad, disabling control of the automatic sensor.

- ➔ Return the sensors to the correct position.

The automatic arm laser line does not work (if present)

To replace the battery, proceed as follows:

- ➔ Remove the four screws in the lever (A, Fig.26) and then remove the plastic casing (B, Fig.26)
- ➔ Pull out the card (C, Fig.26) inside
- ➔ Replace the battery in the card with a new CR2450 3V;
- ➔ Continue to mount the lever in the opposite direction to disassembly.

CAUTION

Pay attention to the positioning of the cables inside the lever groove to prevent accidentally damaging the cable while closing the plastic crankcase.

If the laser line does not work with the new battery, call for technical assistance.

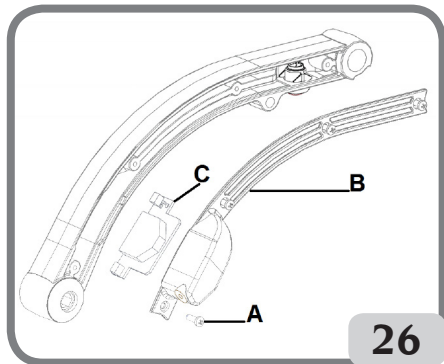

Pressing the START key the wheel does not spin (the machine does not start)

- Contact the technical support centre.

The wheel balancer provides unsteady unbalance values

The machine was jolted during the spin.

- Repeat the spin, taking care not to disturb the machine while measuring is in progress.

The machine does not firmly rest on the floor.

- Make sure that the floor support is firm

The wheel is not locked correctly.

- Tighten the securing ring nut correctly.

Several spins are to be performed to balance the wheel

The machine was jolted during the spin.

- Repeat the spin, taking care not to disturb the machine while measuring is in progress.

The machine does not firmly rest on the floor.

- Make sure that the floor support is firm.

The wheel is not locked correctly.

- Tighten the securing ring nut correctly.

The machine has not been calibrated correctly.

- Carry out the sensitivity calibration procedure.

The entered geometric data are not correct.

Check that the data corresponds to the dimensions of the wheel and correct, if necessary.

- Perform the width sensor calibration procedure.

LED light and/or laser indicator are NOT working

- Check if the device(s) is (are) configured correctly as shown in the paragraphs "SET UP - LED light" and "SET UP - Laser indicator". If the problem persists after checking the correct device configuration, call the technical support centre.

UK



CAUTION

The "Spare parts" handbook does not authorise the user to carry out work on the machine with the exception of those operations explicitly described in the User Manual. It only enables the user to provide the technical assistance service with precise information, to minimise delays.

MAINTENANCE



CAUTION

The company is not to be held responsible for any claims deriving from the use of non-original spare parts or accessories.



CAUTION

Unplug the machine from the socket and make sure that all moving parts have been locked before making any adjustments or maintenance work.

Do not remove or modify any part of the machine (except for service interventions).



WARNING

Keep the working area clean.

Never use compressed air and/or jets of water to remove dirt or residues from the machine.

Take all possible measures to prevent dust from building up or raising during cleaning operations.

Keep the wheel balancer shaft, the securing ring nut, the centring cones and flange clean. These components can be cleaned using a brush previously dipped in environmentally friendly solvents.

Handle cones and flanges carefully so as to avoid accidental dropping and subsequent damage that would affect centring accuracy.

After use, store cones and flanges in a place where they are suitably protected from dust and dirt.

If necessary, use ethyl alcohol to clean the display panel.

Perform the calibration procedure at least once every six months.

INFORMATION REGARDING MACHINE DEMOLITION

If the machine is to be scrapped, remove all electrical, electronic, plastic and metal parts and dispose of them separately in accordance with current provisions as prescribed by law.

ENVIRONMENTAL INFORMATION

The disposal procedure described below only applies to machines with the symbol of the

waste bin with a bar across it



on their data plates.

This product may contain substances that can be hazardous to the environment and to human health if it is not disposed of properly.

The following information is therefore provided to prevent the release of these substances and to improve the use of natural resources.

Electrical and electronic equipment must never be disposed of in the usual municipal

waste but must be separately collected for their proper treatment. The crossed-out bin symbol, placed on the product and on this page, reminds the user that the product must be disposed of properly at the end of its life. In this way it is possible to prevent that a non specific treatment of the substances contained in these products, or their improper use, or improper use of their parts may be hazardous to the environment or to human health. Furthermore, this helps to recover, recycle and reuse many of the materials contained in these products.

Electrical and electronic manufacturers and distributors set up proper collection and treatment systems for these products for this purpose. Contact your local distributor to obtain information on the collection procedures at the end of the life of your product.

When purchasing this product, your distributor will also inform you of the possibility to return another end-of-life piece of equipment free of charge as long as it is of equivalent type and had the same functions as the purchased product.

Any disposal of the product performed in a different way from that described above will be liable to the penalties provided for by the national regulations in force in the country where the product is disposed of.

Further measures for environmental protection are recommended: recycling of the internal and external packaging of the product and proper disposal of used batteries (only if contained in the product).

Your help is crucial in reducing the amount of natural resources used for manufacturing electrical and electronic equipment, minimise the use of landfills for product disposal and improve the quality of life, preventing potentially hazardous substances from being released in the environment.

FIRE-EXTINGUISHING MATERIALS TO BE USED

Consult the following table to choose the most suitable fire extinguisher.

	Dry materials	Flammable liquids	Electrical equipment
Water	YES	NO	NO
Foam	YES	YES	NO
Powder	YES*	YES	YES
CO ₂	YES*	YES	YES

YES* *Use only if more appropriate extinguishers are not at hand or when the fire is small.*



CAUTION

The indications in this table are of a general nature. They are designed as a guideline for the user. The applications of each type of extinguisher will be illustrated fully by the respective manufacturers on request.

GLOSSARY

Below is a brief description of some technical terms used in this manual.

SELF-CALIBRATION

This procedure calculates suitable correction coefficients starting from known operating conditions. It improves the machine accuracy by correcting to a certain extent the calculation errors that may result from the alteration of the machine's features over the course of time.

AWC

Auto Width Calculation acronym

CALIBRATION

See SELF-CALIBRATION.

CENTRING

Procedure for positioning the wheel on the wheel balancer shaft to ensure that the shaft axis corresponds to the wheel rotation axis.

BALANCING CYCLE

Sequence of operations to be performed by the user and the machine from the beginning of the spin until the wheel is braked to a stop after calculating the unbalance values.

CONE

Conical element with a central hole which, when inserted on the wheel balancer shaft, is used to centre the wheels having central holes with a diameter ranging between maximum and minimum values.

DYNAMIC BALANCING

Procedure for unbalance compensation by applying two weights, one on each of the two wheel sides.

STATIC BALANCING

Procedure for correcting only the static element of the unbalance, by applying only one weight, usually at the centre of the rim well. Accuracy increases as the width of the wheel decreases.

FLANGE (of the wheel balancer)

Circular crown-shaped disk against which the disk of the wheel mounted on the wheel balancer rests. Also used for keeping the wheel perfectly perpendicular to its rotation axis.

FLANGE (adapter - centring accessory)

Device for supporting and centring the wheel. Also used for keeping the wheel perfectly perpendicular to its rotation axis.

Mounted on the shaft of the wheel balancer by means of the central bore.

FSP

Fast Selection Program acronym

RING NUT

Wheel blocking device on the wheel balancer, fitted with elements for coupling with the threaded hub and side pins for tightening it.

SPIN

Procedure starting from the action that causes the wheel to rotate and the subsequent rotation of the wheel.

THREADED HUB

Threaded part of the shaft on which the ring nut is engaged to lock the wheel. It is supplied disassembled from the machine.

OPT

Optimisation abbreviation.

RPA

Acronym of Ricerca Posizione Automatica (Automatic Position Search).

UNBALANCE

Uneven distribution of the wheel mass that generates centrifugal forces during rotation.

SENSOR (measuring arm)

Mobile mechanical element that, when brought into contact with the rim in a specific position, measures the geometric data: distance, diameter. Data can be measured automatically if the sensor is equipped with suitable measurement transducers.

ELECTRICAL SYSTEM GENERAL DIAGRAM

AP2	Mother board (CPU)
AP5	Search card
BP1	Internal pick-up
BP2	External pick-up
FU1	Fuse
FU2	Fuse
M1	Motor
QS1	Main switch
RP3	Outer distance potentiometer
SQ8	Micro-switch automatic wheel locking system
JP	Jumper
XS1	Power supply socket
BR2	Diameter measuring sensor
BR3	Distance measuring sensor
BR5	LASER indicator
BR9	Sonar sensor external distance
AP22	LED light
YA2	Brake coil / motor release
EVA	Opening solenoid valve
EVC	Closing solenoid valve



